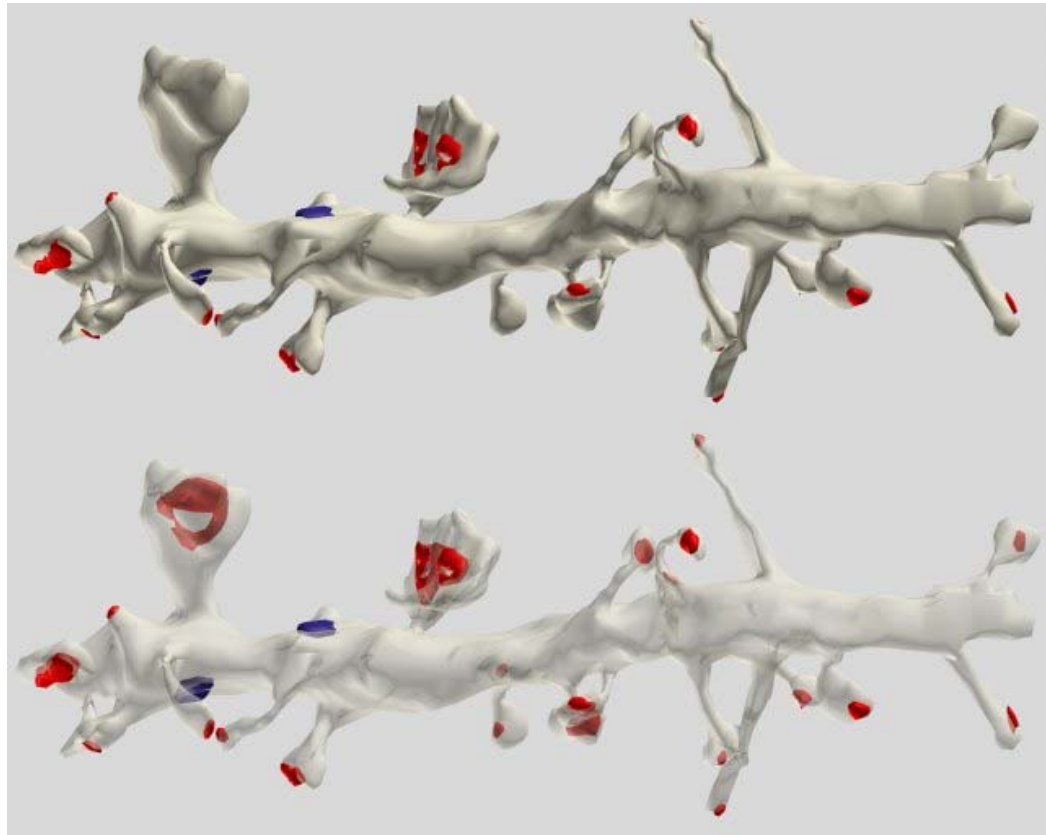


# Whole Brain Emulation

## A Roadmap



(2008) *Technical Report #2008-3*

Anders Sandberg\*  
Nick Bostrom

Future of Humanity Institute  
Faculty of Philosophy & James Martin 21<sup>st</sup> Century School  
Oxford University

CITE: Sandberg, A. & Bostrom, N. (2008): *Whole Brain Emulation: A Roadmap*, Technical Report #2008-3, Future of  
Humanity Institute, Oxford University  
URL: [www.fhi.ox.ac.uk/reports/2008-3.pdf](http://www.fhi.ox.ac.uk/reports/2008-3.pdf)

(\*) Corresponding author: [anders.sandberg@philosophy.ox.ac.uk](mailto:anders.sandberg@philosophy.ox.ac.uk)

*In memoriam: Bruce H. McCormick (1930 – 2007)*

# Contents

Whole Brain Emulation.....	1
A Roadmap .....	1
<i>In memoriam: Bruce H. McCormick (1930 – 2007)</i> .....	2
Contents.....	3
Introduction .....	5
Thanks to .....	6
The concept of brain emulation.....	7
Emulation and simulation.....	7
Little need for whole-system understanding.....	8
Levels of emulation and success criteria.....	10
Scale separation.....	12
Simulation scales.....	13
WBE assumptions.....	15
Roadmap .....	16
Requirements.....	16
Linkages.....	19
Roadmap .....	20
Technology drivers.....	23
Uncertainties and alternatives.....	24
Alternative pathways.....	27
Related technologies and spin-offs.....	28
Issues.....	30
Emulation systems.....	30
Complications and exotica .....	31
Summary .....	39
Scanning .....	40
Embedding, fixation and staining techniques .....	52
Conclusion .....	53
Image processing and scan interpretation.....	55
Geometric adjustment.....	55
Noise removal .....	56
Data interpolation.....	56
Cell tracing.....	57
Synapse identification.....	59
Identification of cell types .....	60
Estimation of parameters for emulation.....	61
Connectivity identification.....	62
Conclusion .....	63
Neural simulation.....	64
How much neuron detail is needed?.....	64
Neural models.....	66
Simulators .....	70
Parallel simulation.....	70
Current large-scale simulations.....	71
Conclusion .....	72
Body simulation .....	74
Conclusion .....	75
Environment simulation.....	76

Vision .....	76
Hearing.....	77
Smell and Taste .....	77
Haptics.....	77
Conclusion .....	78
Computer requirements .....	79
Conclusions.....	81
Validation.....	82
Discussion .....	83
Appendix A: Estimates of the computational capacity/demands of the human brain .....	84
Appendix B: Computer Performance Development .....	86
Processing Power.....	86
Memory .....	95
Disc drives.....	97
Future.....	98
Appendix C: Large-scale neural network simulations.....	101
Appendix D: History and previous work.....	105
Appendix E: Non-destructive and gradual replacement.....	107
Non-Destructive Scanning .....	107
Gradual replacement.....	108
Appendix F: Glossary.....	110
References .....	113

# *Introduction*

Whole brain emulation (WBE), the possible future one-to-one modelling of the function of the human brain, is academically interesting and important for several reasons:

- Research
  - Brain emulation is the logical endpoint of computational neuroscience's attempts to accurately model neurons and brain systems.
  - Brain emulation would help us to understand the brain, both in the lead-up to successful emulation and afterwards by providing an ideal test bed for neuroscientific experimentation and study.
  - Neuromorphic engineering based on partial results would be useful in a number of applications such as pattern recognition, AI and brain-computer interfaces.
  - As a long-term research goal it might be a strong vision to stimulate computational neuroscience.
  - As a case of future studies it represents a case where a radical future possibility can be examined in the light of current knowledge.
- Economics
  - The economic impact of copyable brains could be immense, and could have profound societal consequences (Hanson, 1994, 2008b). Even low probability events of such magnitude merit investigation.
- Individually
  - If emulation of particular brains is possible and affordable, and if concerns about individual identity can be met, such emulation would enable back-up copies and "digital immortality".
- Philosophy
  - Brain emulation would itself be a test of many ideas in the philosophy of mind and philosophy of identity, or provide a novel context for thinking about such ideas.
  - It may represent a radical new form of human enhancement.

WBE represents a formidable engineering and research problem, yet one which appears to have a well-defined goal and could, it would seem, be achieved by extrapolations of current technology. This is unlike many other suggested radically transformative technologies like artificial intelligence where we do not have any clear metric of how far we are from success.

In order to develop ideas about the feasibility of WBE, ground technology foresight and stimulate interdisciplinary exchange, the Future of Humanity Institute hosted a workshop on May 26 and 27, 2007, in Oxford. Invited experts from areas such as computational neuroscience, brain-scanning technology, computing, nanotechnology, and neurobiology presented their findings and discussed the possibilities, problems and milestones that would have to be reached before WBE becomes feasible.

The workshop avoided dealing with socioeconomic ramifications and with philosophical issues such as theory of mind, identity or ethics. While important, such discussions would undoubtedly benefit from a more comprehensive understanding of the brain—and it was this understanding that we wished to focus on furthering during the workshop. Such issues will likely be dealt with at future workshops.

This document combines an earlier whitepaper that was circulated among workshop participants, and additions suggested by those participants before, during and after the workshop. It aims at providing a preliminary roadmap for WBE, sketching out key technologies that would need to be developed or refined, and identifying key problems or uncertainties.

Brain emulation is currently only a theoretical technology. This makes it vulnerable to speculation, “handwaving” and untestable claims. As proposed by Nick Szabo, “falsifiable design” is a way of curbing the problems with theoretical technology:

...the designers of a theoretical technology in any but the most predictable of areas should identify its assumptions and claims that have not already been tested in a laboratory. They should design not only the technology but also a map of the uncertainties and edge cases in the design and a series of such experiments and tests that would progressively reduce these uncertainties. A proposal that lacks this admission of uncertainties coupled with designs of experiments that will reduce such uncertainties should not be deemed credible for the purposes of any important decision. We might call this requirement a requirement for a *falsifiable design*. (Szabo, 2007)

In the case of brain emulation this would mean not only sketching how a brain emulator would work if it could be built and a roadmap of technologies needed to implement it, but also a list of the main uncertainties in how it would function and proposed experiments to reduce these uncertainties.

It is important to emphasize the long-term and speculative nature of many aspects of this roadmap, which in any case is to be regarded only as a first draft—to be updated, refined, and corrected as better information becomes available. Given the difficulties and uncertainties inherent in this type of work, one may ask whether our study is not premature. Our view is that when the stakes are potentially extremely high, it is important to apply the best available methods to try to understand the issue. Even if these methods are relatively weak, it is the best we can do. The alternative would be to turn a blind eye to what could turn out to be a pivotal development. Without first studying the question, how is one to form any well-grounded view one way or the other as to the feasibility and proximity of a prospect like WBE?

## Thanks to

We would like to warmly thank the many people who have commented on the paper and helped extend and improve it:

**Workshop participants:** John Fiala, Robin Hanson, Kenneth Jeffrey Hayworth, Todd Huffman, Eugene Leitl, Bruce McCormick, Ralph Merkle, Toby Ord, Peter Passaro, Nick Shackel, Randall A. Koene, Robert A. Freitas Jr and Rebecca Roache.

**Other useful comments:** Stuart Armstrong.

# *The concept of brain emulation*

Whole brain emulation, often informally called “uploading” or “downloading”, has been the subject of much science fiction and also some preliminary studies (see Appendix D for history and previous work). The basic idea is to take a particular brain, scan its structure in detail, and construct a software model of it that is so faithful to the original that, when run on appropriate hardware, it will behave in essentially the same way as the original brain.

## **Emulation and simulation**

The term emulation originates in computer science, where it denotes mimicking the function of a program or computer hardware by having its low-level functions simulated by another program. While a simulation mimics the outward results, an emulation mimics the internal causal dynamics (at some suitable level of description). The emulation is regarded as successful if the emulated system produces the same outward behaviour and results as the original (possibly with a speed difference). This is somewhat softer than a strict mathematical definition<sup>1</sup>.

According to the Church-Turing thesis, a Turing machine can emulate any other Turing machine. The physical Church-Turing thesis claims that every physically computable function can be computed by a Turing machine. This is the basis for brain emulation: if brain activity is regarded as a function that is physically computed by brains, then it should be possible to compute it on a Turing machine. Even if true, however, it does not demonstrate that it is a computationally feasible process.

In the following, *emulation* will refer to a 1-to-1 model where all relevant properties of a system exist, while a *simulation* will denote a model where only some properties exist. Emulations may behave differently from each other or the original due to noise or intrinsic chaos, but behave within the range of what one would expect from the original if it had experienced the same noise or chaos.

By analogy with a software emulator, we can say that a *brain emulator* is software (and possibly dedicated non-brain hardware) that models the states and functional dynamics of a brain at a relatively fine-grained level of detail.

In particular, a *mind emulation* is a brain emulator that is detailed and correct enough to produce the phenomenological effects of a mind.

---

<sup>1</sup> A strict definition of simulation might be that a system  $S$  consists of a state  $x(t)$  evolving by a particular dynamics  $f$ , influenced by inputs and producing outputs:  $x(t+1) = f(I, x(t))$ ,  $O(t) = g(x(t))$ . Another system  $T$  simulates  $S$  if it produces the same output (within a tolerance) for the same input time series starting with a given state (within a tolerance):  $X(t+1) = F(I, X(t))$ ,  $O(t) = G(X(t))$  where  $|x(t) - X(t)| < \epsilon_1$  and  $X(0) = x(0) + \epsilon_2$ . The simulation is an emulation if  $F = f$  (up to a bijective transformation of  $X(t)$ ), that is, the internal dynamics is identical and similar outputs are not due to the form of  $G(X(t))$ .

Chaotic systems are not simulable by this definition, since after enough time they will diverge if the initial conditions differ. Since even a three neuron system can become chaotic (Li, Yu et al., 2001) it is very plausible that the brain contains chaotic dynamics and it is not strictly simulable. However, there exists a significant amount of noise in the brain that does not prevent meaningful brain states from evolving despite the indeterminacy of their dynamics. A “softer” form of emulation may be possible to define that has a model or parameter error smaller than the noise level and is hence *practically* indistinguishable from a possible evolution of the original system.

A *person emulation* is a mind emulation that emulates a particular mind.

What the “relevant properties” are is a crucial issue. In terms of software emulation this is often the bits stored in memory and how they are processed. A computer emulator may emulate the processor, memory, I/O and so on of the original computer, but does not simulate the actual electronic workings of the components, only their qualitative function on the stored information (and its interaction with the outside world). While lower-level emulation of computers may be possible it would be inefficient and not contribute much to the functions that interest us.

Depending on the desired success criterion emulation may require different levels of detail. It might also use different levels of detail in different parts of the system. In the computer example, emulating the result of a mathematical calculation may not require simulating the execution of all operating system calls for math functions (since these can be done more efficiently by the emulating computer’s processor) while emulating the behaviour of an analogue video effect may require a detailed electronics simulation.

### Little need for whole-system understanding

An important hypothesis for WBE is that in order to emulate the brain we do not need to understand the whole system, but rather we just need a database containing all necessary low-level information about the brain and knowledge of the local update rules that change brain states from moment to moment. A functional understanding (why is a particular piece of cortex organized in a certain way) is logically separate from detail knowledge (how is it organised, and how does this structure respond to signals). Functional understanding may be a possible result from detail knowledge and it may help gather only the relevant information for WBE, but it is entirely possible that we could acquire full knowledge of the component parts and interactions of the brain without gaining an insight into how these produce (say) consciousness or intelligence.

Even a database merely containing the complete “parts list” of the brain, including the morphology of its neurons, the locations, sizes and types of synaptic connections, would be immensely useful for research. It would enable data-driven research in the same way as genomics has done in the field of cell biology (Fiala, 2002).

Computational neuroscience attempts to understand the brain by making mathematical or software models of neural systems. Currently, the models are usually far simpler than the studied systems, with the exception of some small neural networks such as the lobster stomatogastric ganglion (Nusbaum and Beenhakker, 2002) and the locomotor network of the lamprey spinal cord (Kozlov, Lansner et al., 2007). Often models involve a combination of simplified parts (simulated neurons and synaptic learning rules) and network structures (subsampling of biological neurons, simple topologies). Such networks can themselves constitute

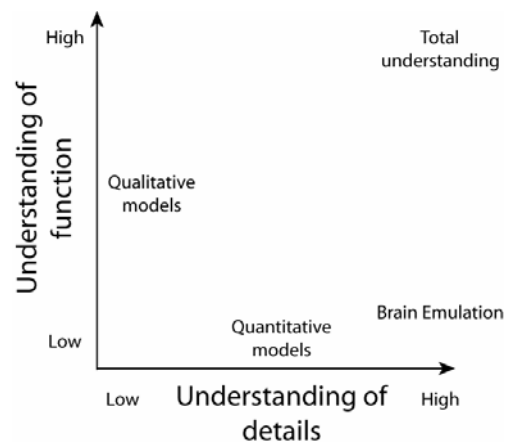


Figure 1: Understanding of function vs. understanding of details.



learning or pattern recognizing systems on their own, artificial neural networks (ANNs). ANN models can be used to qualitatively model, explain and analyze the functions of brain systems (Rumelhart, McClelland et al., 1986). Connectionist models build more complex models of cognition or brain function on these simpler parts. The end point of this pursuit would be models that encompass a full understanding of the function of all brain systems. Such qualitative models might not exhibit intelligence or the complexity of human behaviour but would enable a formalized understanding of how they come about from simple parts.

Another approach in computational neuroscience involves creating more biologically realistic models, where information about the biological details of neurons such as their electrochemistry, biochemistry, detailed morphology and connectivity are included. At its simplest we find compartment models of individual neurons and synapses, while more complex models include multiple realistic neurons connected into networks, possibly taking interactions such as chemical volume transmission into account. This approach can be seen as a quantitative understanding of the brain, aiming for a complete list of the biological parts (chemical species, neuron morphologies, receptor types and distribution etc.) and modelling as accurately as possible the way in which these parts interact. Given this information increasingly large and complex simulations of neural systems can be created. WBE represents the logical conclusion of this kind of quantitative model: a 1-to-1 model of brain function.

Note that the amount of functional understanding needed to achieve a 1-to-1 model is small. Its behaviour is emergent from the low-level properties, and may or may not be understood by the experimenters. For example, if coherent oscillations are important for conceptual binding and these emerge from the low-level properties of neurons and their networks, a correct and complete simulation of these properties will produce the coherence.

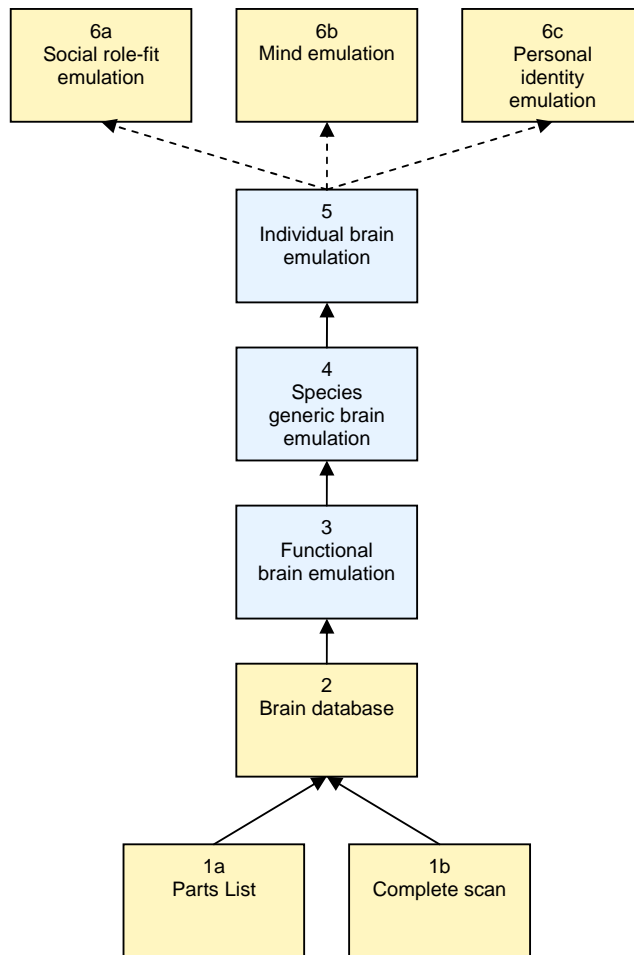
In practice computational neuroscience works in between quantitative and qualitative models. Qualitative models are used to abstract complex, uncertain and potentially irrelevant biological data, and often provide significant improvements in simulation processing demands (in turn enabling larger simulations, which may enable exploration of domains of more interest). Quantitative models are more constrained by known biology, chemistry and physics but often suffer from an abundance of free parameters that have to be set (Herz, Gollisch et al., 2006). Hybrid models may include parts using different levels of abstraction, or exist as a family of models representing the same system at different levels of abstraction.

The interplay between biological realism (attempting to be faithful to biology), completeness (using all available empirical data about the system), tractability (the possibility of quantitative or qualitative simulation) and understanding (producing a compressed representation of the salient aspects of the system in the mind of the experimenter) will often determine what kind of model is used. The appropriate level of abstraction and method of implementation depends on the particular goal of the model. In the case of WBE, the success criteria discussed below place little emphasis on understanding, but much emphasis on qualitatively correct dynamics, requiring much biological realism (up to a point, set by scale separation) and the need for data-driven models. Whether such models for whole brain systems are tractable from a modelling and simulation standpoint is the crucial issue.

Brain emulation cannot be achieved without *some* functional understanding. It needs models and theories for recognizing what data is relevant, and would provide data for developing and testing these further. While in theory brain emulation might hug the lower line in Figure 1, in practice it will likely occur somewhere along the right edge – still far below a full understanding of the top level phenomena, but including a broad understanding of many

kinds of low level phenomena. We also need some understanding of higher level phenomena to test our simulations and know what kind of data we need to pursue. Fostering the right research cycle for developing the right understanding, collecting data, improving instrumentation, and experimenting with limited emulations – in addition to providing useful services to related fields and beneficial spin-offs – would be indispensable for the development of WBE.

## Levels of emulation and success criteria



**Figure 2: Success levels for WBE.**

philosophical interest in WBE we have included them here for completeness. It is not obvious how these criteria relate to one another, or to what extent they might be entailed by the criteria for 4 and 5.

Achieving the third success criterion beyond a certain resolution would, assuming some supervenience thesis, imply success of some or all of the other criteria. A full quantum-mechanical N-body or field simulation encompassing every particle within a brain would plausibly suffice even if “quantum mind” theories are correct. At the very least a 1-to-1 material copy of the brain (a somewhat inflexible and very particular kind of emulating computer) appears to achieve all criteria, possibly excepting those for 6c. However, this is

For the brain, several levels of success criteria for emulation can be used. They form a hierarchy extending from low-level targets to complete emulation. See Table 1 on page 11.

Not shown in this hierarchy are emulations of subsystems or small volumes of the brain, “partial brain emulations”.

Properly speaking, a complete scan, parts list and brain database (1a, 1b and 2) do not constitute successful brain emulation, but such achievements (and partial brain emulations) would in any case be important milestones and useful in themselves.

Similarly, the high-level achievements related to social roles, mental states, and personal identify (6a, 6b and 6c) are both poorly-understood and hard to operationalize, but given the

likely an excessively detailed level since the particular phenomena we are interested in (brain function, psychology, mind) appear to be linked to more macroscopic phenomena than detailed atomic activity.

Given the complexities and conceptual issues of consciousness we will not examine criteria 6abc, but mainly examine achieving criteria 1-5.

**Table 1: Success Criteria**

Level		Success criterion	Relevant properties
1a	"Parts list"	An inventory of all objects on a particular size scale, their properties and interactions.	Low level neural structure, chemistry, dynamics accurate to resolution level.
1b	"Complete scan"	A complete 3D scan of a brain at high resolution.	Resolution, information enabling structure to function mapping.
2	"Brain database"	Combining the scan and parts list into a database mapping the low level objects of a brain.	1-to-1 mapping of scan to simulation/emulation objects.
3	"Functional brain emulation"	The emulation simulates the objects in a brain database with enough accuracy to produce (at least) a substantial range of species-typical basic emergent activity of the same kind as a brain (e.g. a slow wave sleep state or an awake state).	Generically correct causal micro-dynamics.
4	"Species generic brain emulation"	The emulation produces the full range of (human) species-typical emergent behavior and learning capacity.	Long term dynamics and adaptation. Appropriate behaviour responses. Full-range learning capacity.
5	"Individual brain emulation"	The emulation produces emergent activity characteristic of that of one particular (fully functioning) brain. It is more similar to the activity of the original brain than any other brain.	Correct internal and behaviour responses. Retains most memories and skills of the particular brain that was emulated. (In an emulation of an animal brain, it should be possible to recognize the particular (familiar) animal.)
6a	"Social role-fit emulation"/"Person emulation"	The emulation is able to fill and be accepted into some particular social role, for example to perform all the tasks required for some normally human job. (Socio-economic criteria involved)	Properties depend on which (range of) social roles the emulation would be able to fit. In a limiting case, the emulation would be able to pass a personalized Turing test: outsiders familiar with the emulated person would be unable to detect whether responses came from original person or emulation.
6b	"Mind emulation"	The emulation produces subjective mental states (qualia, phenomenal experience) of the same kind that would have been produced by the particular brain being emulated. (Philosophical criteria involved)	The emulation is truly conscious in the same way as a normal human being.
6c	"Personal identity emulation"	The emulation is correctly described as a continuation of the original mind; either as numerically the same person, or as a surviving continuer thereof. (Philosophical criteria involved)	The emulation is an object of prudentially rational self-concern for the brain to be emulated.

## Scale separation

At first it may appear unlikely that a complex system with many degrees of freedom like the brain could be modelled with the right causal dynamics, but without taking into account the smallest parts. Microstimulation of individual neurons can influence sensory decisions (Houweling and Brecht, 2008), showing that very small disturbances can – under the right circumstances – scale up to behavioural divergences.

However, state variables of complex systems can be quantitatively predicted when there is ‘scale separation’: when different aspects of the system exist on sufficiently (orders of magnitude) different scales (of size, energy, time etc), they can become uncoupled (Hillerbrand, 2008). A typical example is how the microscopic dynamics of a laser (atoms interacting with an oscillating electromagnetic field) gives rise to a macroscopic dynamics (the growth and decay of different laser modes) in such a way that an accurate simulation of the system using only elements on the macroscale is possible. Another example is the scale separation between electric currents and logic operations in a computer, which enables bit-based emulation. When there is no scale separation (such as in fluid turbulence) macroscale predictions become impossible without simulating the entire microscale.

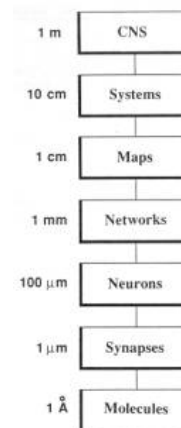
An important issue to be determined is whether such a cut-off exists in the case of the human brain and, if it does exist, at what level. While this paper phrases it in terms of simulation/emulation, it is encountered in a range of fields (AI, cognitive neuroscience, philosophy of mind) in other forms: what level of organisation is necessary for intelligent, personal, or conscious behaviour?

A key assumption of WBE is that, at some intermediary level of simulation resolution between the atomic and the macroscopic, there exists at least one cut-off such that meeting criteria 1a and 1b at this level of resolution also enables the higher criteria to be met.

At such a spatial, temporal, or organisational scale, the dynamics on the larger/slower scale is not functionally sensitive to the dynamics of the smaller/faster scale. Such scale separation might occur at the synaptic scale, where the detailed chemical dynamics underlying synaptic function could be replaced by a simplified qualitative model of its effects on signals and synaptic strengths. Another possible scale separation level might occur between individual molecules and molecular concentration scales: molecular dynamics could be replaced with mass-action interactions of concentrations. A perhaps less likely separation could also occur on higher levels if what matters is the activity of cortical minicolumns rather than individual neurons. A final likely but computationally demanding scale or separation would be the atomic scale, treating the brain emulation as a N-body system of atoms.

Conversely, if it could be demonstrated that there is no such scale, it would demonstrate the infeasibility of whole brain emulation. Due to causally important influence from smaller scales in this case, a simulation at a particular scale cannot become an emulation. The causal dynamics of the simulation is not internally constrained, so it is not a 1-to-1 model of the relevant dynamics. Biologically interesting simulations might still be possible, but they would be

local to particular scales and phenomena, and they would not fully reproduce the internal causal structure of the whole brain.



**Figure 3: Size scales in the nervous system.**

## Simulation scales

The widely reproduced diagram from (Churchland and Sejnowski, 1992) in Figure 3 depicts the various levels of organisation in the nervous system ordered by size scale, running from the molecular level to the entire system. Simulations (and possibly emulations) can occur on all levels:

- Molecular simulation (individual molecules)
- Chemistry simulation (concentrations, law of mass action)
- Genetic expression
- Compartment models (subcellular volumes)
- Whole cell models (individual neurons)
- Local network models (replaces neurons with network modules such as minicolumns)
- System models

Another hierarchy was introduced by John Fiala during the workshop, and will be used with some adaptations in this document.

**Table 2: Levels of emulation**

Level		
1	Computational module	“Classic AI”, high level representations of information and information processing.
2	Brain region connectivity	Each area represents a functional module, connected to others according to a (species universal) “connectome” (Sporns, Tononi et al., 2005).
3	Analog network population model	Neurons populations and their connectivity. Activity and states of neurons or groups of neurons are represented as their time-averages. This is similar to connectionist models using ANNs, rate-model neural simulations and cascade models.
4	Spiking neural network	As above, plus firing properties, firing state and dynamical synaptic states. Integrate and fire models, reduced single compartment models (but also some minicolumn models, e.g. (Johansson and Lansner, 2007)).
5	Electrophysiology	As above, plus membrane states (ion channel types, properties, state), ion concentrations, currents, voltages and modulation states. Compartment model simulations.
6	Metabolome	As above, plus concentrations of metabolites and neurotransmitters in compartments.
7	Proteome	As above, plus concentrations of proteins and gene expression levels.
8	States of protein complexes	As above, plus quaternary protein structure.
9	Distribution of complexes	As above, plus “locomote” information and internal cellular geometry.
10	Stochastic behaviour of single molecules	As above plus molecule positions, or a molecular mechanics model of the entire brain.
11	Quantum	Quantum interactions in and between molecules.

The amount of understanding needed to accurately simulate the relevant objects tends to increase radically for higher (here, low-numbered) levels: while basic mechanics is well understood, membrane biophysics is complex, and the computational functions of brain areas are likely exceedingly multifaceted. Conversely, the amount of computing power needed increases rapidly as we descend towards lower levels of simulation, and may become fundamentally infeasible on level 11<sup>2</sup>. The amount and type data needed to fully specify a

<sup>2</sup> But see also the final chapter of (Hameroff, 1987). The main stumbling block of level 11 simulation may not be computing hardware or understanding but fundamental quantum limitations on scanning.

model also changes character between the different levels. Low-level simulations require massive quantities of simple information (molecular positions and types) whereas higher levels require a smaller amount of very complex information (content of mental processes).

Each level has its own characteristic size and time scale, restricting the required imaging resolution and simulation timestep. For example, synaptic spine necks and the thinnest axons can be on the order of 50 nm or smaller, requiring imaging on the order of the 5 nanometer scale to resolve them.

An informal poll among workshop attendees produced a range of estimates of the required resolution for WBE is. The consensus appeared to be level 4-6. Two participants were more optimistic about high level models, while two suggested that elements on level 8-9 may be necessary at least initially (but that the bulk of mature emulation, once the basics were understood, could occur on level 4-5). To achieve emulation on this level, the consensus was that 5×5×50 nm scanning resolution would be needed. This roadmap will hence focus on level 4-6 models, while being open for that deeper levels may turn out to be needed.

As noted by Fiala, WBE likely requires at least level 4 to capture the specificity of individual brains, but probably requires complexity at level 6 or lower to fully capture the computational contributions of ion channels, second messengers, protein level adaptation, and stochastic synaptic transmission. Other participants thought that at least level 5 would be needed for individual brain properties.

## Forecasting

Analysing the requirements for emulation (in terms of scanning method, number of entities to simulate, resulting storage requirements and computational demands) at each of the levels provides a way of bounding progress towards WBE. Given these estimates and scenarios of future progress in scanning and computing it is possible to calculate the earliest point in time where there is enough resources to produce a WBE on a given level at a certain price. As better information becomes available such estimates can be refined.

Although any time estimates will be subject to strong uncertainties, they can be helpful in estimating how far away WBE is from policy-relevant timescales, as well as likely timeframes for early small-scale emulations. They also allow comparisons to other technology forecasts, enabling estimation of the chances for synergies (e.g. the development of molecular nanotechnology, which would accelerate WBE progress), reliability (e.g. the further into the future, the more unlikely Moore's law is to hold), and the risk of other technologies overtaking WBE (e.g. artificial intelligence).

Early WBE may require lower-level simulation than later forms, as there might not yet be enough experience (and test systems) to determine which simulation elements are strictly necessary for success. The main concern in this document is estimating when and how WBE will first be achieved rather than its eventual mature or "best" form.

## WBE assumptions

### Philosophical assumptions

**Physicalism** (everything supervenes on the physical) is a convenient but not necessary assumption, since some non-physicalist theories of mental properties could allow them to appear in the case of WBE. Success criterion 6b emulation assumes **multiple realizability** (that the same mental property, state, or event can be implemented by different physical properties, states, and events). Sufficient apparent success with WBE would provide persuasive evidence for multiple realizability. Generally, emulation up to and including level 6a does not appear to depend on any strong metaphysical assumptions.

### Computational assumptions

**Computability**: brain activity is Turing-computable, or if it is uncomputable, the uncomputable aspects have no functionally relevant effects on actual behaviour.

**Non-organicism**: total understanding of the brain is not required, just component parts and their functional interactions.

**Scale separation**: at some intermediary level of simulation resolution between the atomic and the macroscopic there exists one (or more) cut-offs such that meeting criterion 2 at this level is sufficient for meeting one or more of the higher criteria.

**Component tractability**: the actual brain components at the lowest emulated level can be understood well enough to enable accurate simulation.

**Simulation tractability**: simulation of the lowest emulated level is computationally tractable with a practically realizable computer.

### Neuroscience assumptions

**Brain-centeredness**: in order to produce accurate behaviour only the brain and *some* parts of the body need to be simulated, not the entire body.

WBE appears to be a way of testing many of these assumptions experimentally. In acquiring accurate data about the structure and function of the brain and representing it as emulations it should be possible to find major discrepancies if, for example, Computability is not true.

# Roadmap

## Requirements

WBE requires three main capabilities: the ability to physically scan brains in order to acquire the necessary information, the ability to interpret the scanned data to build a software model, and the ability to simulate this very large model. These in turn require a number of subcapabilities (Table 3: Capabilities needed for WBE).

Plausible scanning methods require ways of preparing the brains, in particular separation from other tissue, fixation and possibly dyeing. There is also a need for methods of physically handling and storing pieces of tissue: since most scanning methods cannot image large volumes the brains will have to be sectioned into manageable pieces. This must allow corresponding cells and dendrites to be identified on both sides. While fixation and sectioning methods are commonly used in neuroscience, the demands for whole brain emulation are stricter: much larger volumes must be handled with far less tolerance for damage.

Imaging methods are discussed in more detail in the chapter on scanning. The three key issues are achieving the necessary resolution to image the smallest systems needed for an emulation, the ability to image (not necessarily simultaneously) the entire brain, and the ability to acquire the functionally relevant information.

Translating the data from the imaging process into software requires sophisticated image processing, the ability to interpret the imagery into simulation-relevant parameters, and having a computational neuroscience model of sufficient precision. The image processing will have to deal with the unavoidable artefacts from scanning such as distortions and noise, as well as occasional lost data. It will likely include methods of converting direct scan data into more compressed forms, such as traced structures, in order to avoid excessive storage needs. The scan interpretation process makes use of this data to estimate the connectivity, and to identify synaptic connections, cell types and simulation parameters. It then places this information in an “inventory database” for the emulation. These steps are discussed in the image processing chapter.

The software model requires both a mathematical model of neural activity and ways of efficiently implementing such models on computers (discussed in the chapter on neural simulation). Computational neuroscience aims at modelling the behaviour of neural entities such as networks, neurons, synapses and learning processes. For WBE, it needs to have sufficiently good models of all relevant kinds of subsystems, along with the relevant parameters set from scan data in order to construct a computational model of the actual brain that was scanned.

To emulate a brain, we need enough computing power to run the basic emulation software, a sufficiently realistic body simulation, and possibly a simulated environment. The key demands are for memory storage to hold the information and processor power to run it at a suitable speed. The massive parallelism of the problem will put some significant demands on the internal bandwidth of the computing system.

In addition, WBE likely requires the development of three supporting technology areas, with which it has a symbiotic relationship. First, validation methods to check that other steps



produce accurate data and models. This includes validation of scanning, validation of scan interpretation, validation of neuroscience models, validations of implementation, and ways of testing the success of WBE. While ordinary neuroscience research certainly aims at validation, it does not systematize it. For a complex multi-step research effort like WBE, integrated validation is likely necessary to ensure that bad data or methods do not confuse later steps in the process. Second, WBE requires significant low-level understanding of neuroscience in order to construct the necessary computational models and scan interpretation methods. This is essentially a continuation and strengthening of systems biology and computational neuroscience aiming at a very complete description of the brain on some size or functional scale. Third, WBE is large-scale neuroscience, requiring methods of automating neuroscientific information gathering and experimentation. This will reduce costs and increase throughput, and is necessary in order to handle the huge volumes of data needed. Large-scale/industrial neuroscience is clearly relevant for other neuroscience projects too.

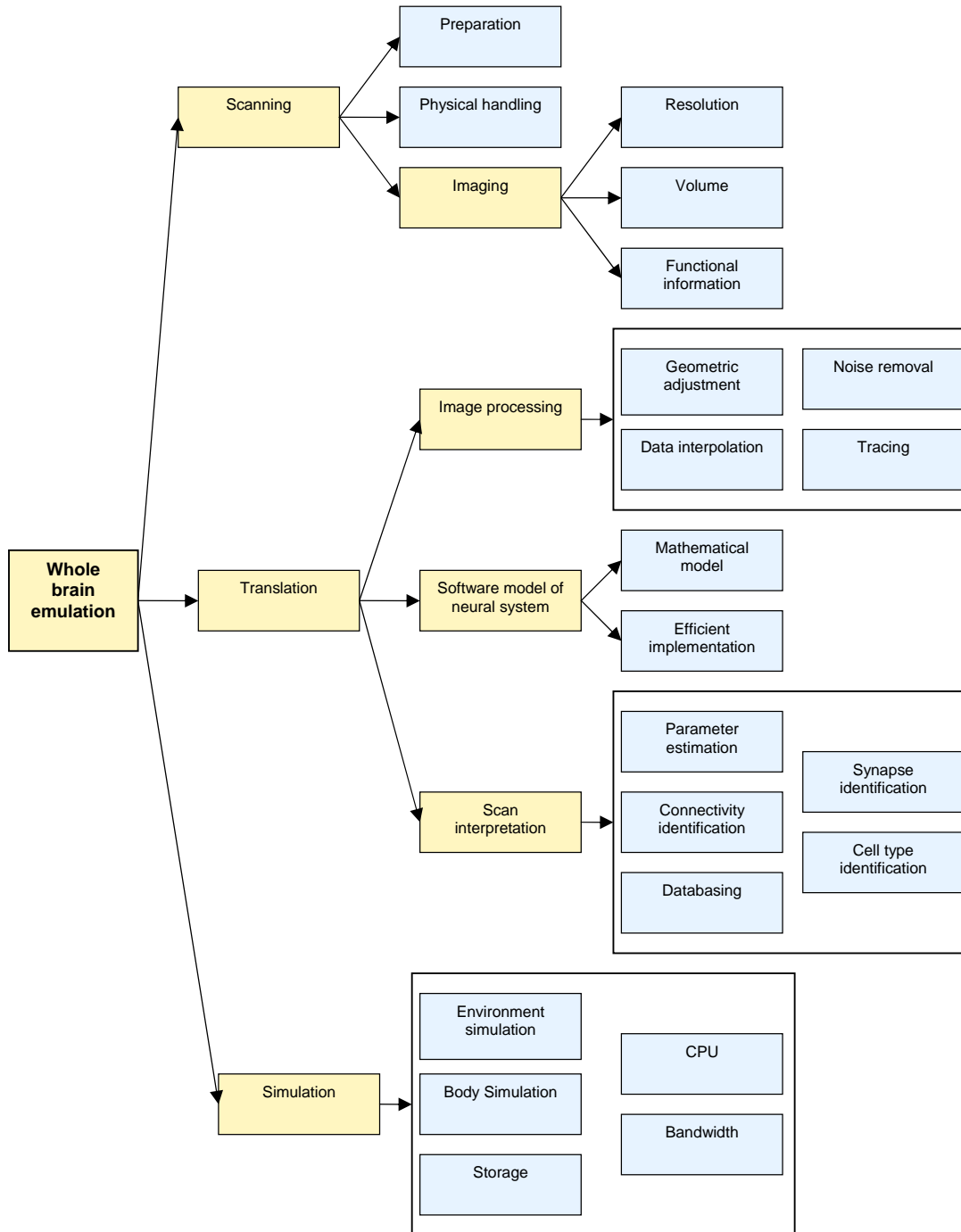


Figure 4: Technological capabilities needed for WBE.

**Table 3: Capabilities needed for WBE**

Scanning	Preprocessing/fixation		Preparing brains appropriately, retaining relevant microstructure and state
	Physical handling		Methods of manipulating fixed brains and tissue pieces before, during, and after scanning
	Imaging	Volume	Capability to scan entire brain volumes in reasonable time and expense.
		Resolution	Scanning at enough resolution to enable reconstruction
Functional information		Scanning is able to detect the functionally relevant properties of tissue	
Translation	Image processing	Geometric adjustment	Handling distortions due to scanning imperfection
		Data interpolation	Handling missing data
		Noise removal	Improving scan quality
		Tracing	Detecting structure and processing it into a consistent 3D model of the tissue
	Scan interpretation	Cell type identification	Identifying cell types
		Synapse identification	Identifying synapses and their connectivity
		Parameter estimation	Estimating functionally relevant parameters of cells, synapses, and other entities
		Databasing	Storing the resulting inventory in an efficient way
Software model of neural system	Mathematical model	Model of entities and their behaviour	
	Efficient implementation	Implementation of model	
Simulation	Storage		Storage of original model and current state
	Bandwidth		Efficient inter-processor communication
	CPU		Processor power to run simulation
	Body simulation		Simulation of body enabling interaction with virtual environment or through robot
	Environment simulation		Virtual environment for virtual body

## Linkages

Most of the capabilities needed for WBE are independent of each other, or form synergistic clusters. Clusters of technologies develop together, supporting and motivating each other with their output. A typical example is better mathematical models stimulating a need for better implementations and computing capacity, while improvements in the latter two stimulate interest in modelling. Another key cluster is 3D microscopy and image processing, where improvements in one makes the other more useful.

There are few clear cases where a capability needs a completed earlier capability in order to begin development. Current fixation and handling methods are likely unable to meet the

demands of WBE-level 3D microscopy, but are good enough to enable early development for certain small systems. Scan interpretation needs enough scan data to develop methods, but given current research the bottleneck appears to be more on the image processing and interpretation side than data availability. Achieving large volume scanning requires parallelization and scaling up previous scanning methods, for example by using robotic work and parallel microscopy. This requires researchers thinking in terms of, and having experience with, an “industrial” approach to data collection.

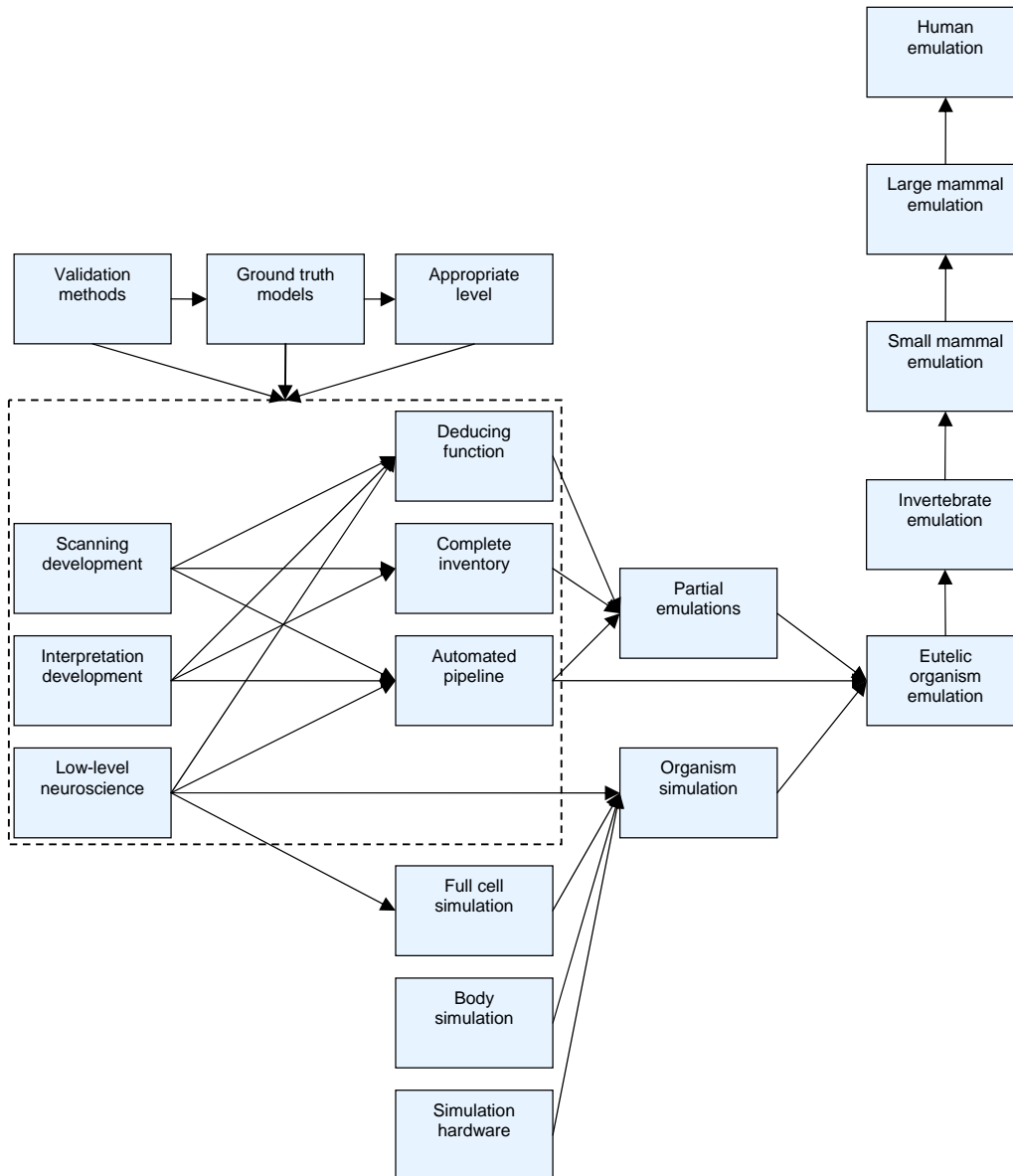
This interlinked nature of the field avoids any obvious technology thresholds and bottlenecks. There is no one technology that *must* be developed before other technologies can advance. Development can occur on a broad front simultaneously, and rapid progress in a field can promote feedback progress in related fields. Unfortunately, it also means that slow progress in one area may hold back other areas, not just due to lack of results but by reduced demand for their findings, reduced funding, and focus on research that does not lead in the direction of WBE.

## Roadmap

Based on these considerations we can sketch out a roadmap with milestones, required technologies, key uncertainties and external technology interactions.

Approach to WBE has two phases. The first phase consists of developing the basic capabilities and settling key research questions that determine the feasibility, required level of detail and optimal techniques. This phase mainly involves partial scans, simulations and integration of the research modalities.

The second phase begins once the core methods have been developed and an automated scan-interpretation-simulate pipeline has been achieved. At this point the first emulations become possible. If the developed methods prove to be scalable they can then be applied to increasingly complex brains. Here the main issue is scaling up techniques that have already been proven on the small scale.



**Figure 5: WBE roadmap.**

The key milestones are:

**Ground truth models:** a set of cases where the biological “ground truth” is known and can be compared to scans, interpretations and simulations in order to determine their accuracy.

**Determining appropriate level of simulation:** this includes determining whether there exists any suitable scale separation in brains (if not, the WBE effort may be severely limited), and if so, on what level. This would then be the relevant scale for scanning and simulation.

**Full cell simulation:** a complete simulation of a cell or similarly complex biological system. While strictly not necessary for WBE it would be a test case for large-scale simulations.

**Body simulation:** an adequate simulation for the model animal's body (and environment). Ideally demonstrated by "fooling" a real animal connected to it.

**Simulation hardware:** special-purpose simulation/emulation computer hardware may be found to be necessary or effective.

**Organism simulation:** a simulation of an entire organism in terms of neural control, body state and environmental interaction. This would not be a true emulation since it is not based on any individual but rather known physiological data for the species. This would enable more realistic and individual models as scans, models and computer power improves.

**Demonstration of function deduction:** demonstrating that all relevant functional properties on a level can be deduced from scan data.

**Complete inventory:** a complete database of entities at some level of resolution for a neural system, e.g. not just the connectivity of the *C. elegans* nervous system but also the electrophysiology of the cells and synapses. This would enable full emulation if all the update rules are known. It demonstrates that the scanning and translation methods have matured.

**Automated pipeline:** a system able to produce a simulation based on an input tissue sample, going through the scan, interpretation and simulation steps without major human intervention. The resulting simulation would be based on the particular tissue rather than being a generic model.

**Partial emulation:** A complete emulation of neural system such as the retina, invertebrate ganglia or a V1 circuit based on scanned and interpreted data from a brain rather than species data. This would demonstrate the feasibility of data-driven brain emulation.

**Eutelic organism emulation:** a complete emulation of a simple organism, such as *C. elegans* or another eutelic (fixed nervous system) organism using data from pipeline scanning. It may turn out that it is unnecessary to start with a eutelic organism and the first organism emulation would be a more complex invertebrate.

**Invertebrate WBE:** Emulation of an invertebrate such as a snail or an insect, with learning. This would test whether the WBE approach can produce appropriate behaviours. If the scanned individual was trained before scanning, retention of trained responses can be checked.

**Small mammal WBE:** Demonstration of WBE in mice or rats, proving that the approach can handle mammalian neuroanatomy.

**Large mammal WBE:** Demonstration in higher mammals, giving further information about how well individuality, memory and skills are preserved as well as investigation of safety concerns.

**Human WBE:** Demonstration of an interactive human emulation.

## Technology drivers

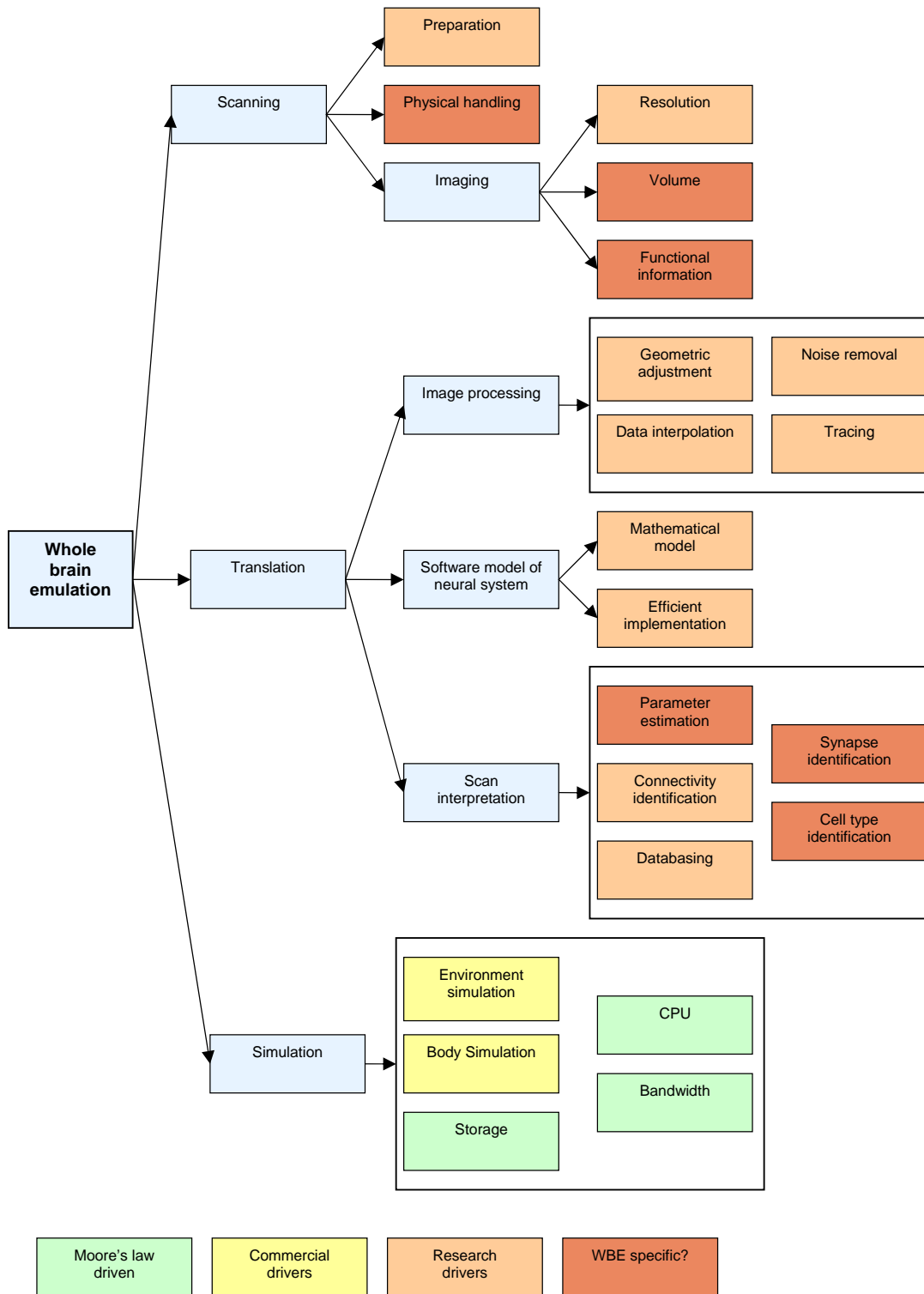


Figure 6: Technology drivers for WBE-necessary technologies.

Different required technologies have different support and drivers for development.

Computers are developed independently of any emulation goal, driven by mass market forces and the need for special high performance hardware. Moore's law and related exponential trends appear likely to continue some distance into the future, and the feedback loops powering them are unlikely to rapidly disappear (see further discussion in Appendix B: Computer Performance Development). There is independent (and often sizeable) investment into computer games, virtual reality, physics simulation and medical simulations. Like computers, these fields produce their own revenue streams and do not require WBE-specific or scientific encouragement.

A large number of the other technologies, such as microscopy, image processing, and computational neuroscience are driven by research and niche applications. This means less funding, more variability of the funding, and dependence on smaller groups developing them. Scanning technologies are tied to how much money there is in research (including brain emulation research) unless medical or other applications can be found. Validation techniques are not widely used in neuroscience yet, but could (and should) become standard as systems biology becomes more common and widely applied.

Finally there are a few areas relatively specific to WBE: large-scale neuroscience, physical handling of large amounts of tissue blocks, achieving high scanning volumes, measuring functional information from the images, automated identification of cell types, synapses, connectivity and parameters. These areas are the ones that need most support in order to enable WBE.

The latter group is also the hardest to forecast, since it has weak drivers and a small number of researchers. The first group is easier to extrapolate by using current trends, with the assumption that they remain unbroken sufficiently far into the future.

## Uncertainties and alternatives

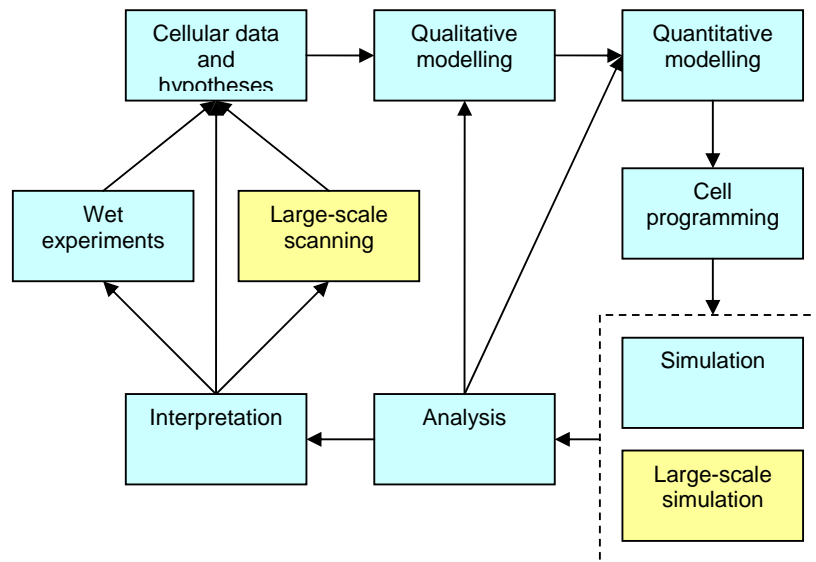
The main uncertainties in the roadmap are:

**Does scale separation enabling WBE occur?** This is a basic science question, and if scale separation does not occur at a sufficiently high scale-level then WBE would be severely limited or infeasible. It is possible that progress in understanding complex systems in general will help clarify the situation. The question of which complex systems are simulable under which conditions is of general interest for many fields. However, in relation to WBE the answer seems most likely to come from advances in computational neuroscience and from trial-and-error. By experimenting with various specialized neural emulations, at different levels of resolution, and comparing the functionally-relevant computational properties of the emulation with those of the emulated subsystem, we can test whether a given emulation is successful. If so, we can infer that a sufficient scale separation for that subsystem exists at (or above) the scale level (granularity) used in the emulation. We emphasize that a successful emulation *need not predict all details of the original behavior* of the emulated system; it need only replicate *computationally relevant functionality* at the desired level of emulation

**What levels are possible/most appropriate for emulation?** This will determine both the requirements for scanning and emulation software. In order to discover it, small-scale scanning and simulation projects need to be undertaken, developing skills and methods. Later, full-scale emulations of small systems will test whether the estimates hold. If an early answer can be found, efforts can focus on this level; otherwise the WBE research front would have to work on multiple levels.



**How much of the functionally relevant information can be deduced from scanning in a particular modality (e.g. electron microscopy)?** At present, electron microscopy appears to be the only scanning method that has the right resolution to reach synaptic connectivity, but it is limited in what chemical state information it can reveal. If it is possible to deduce the function of a neuron, synapse or other structure through image interpretation methods, then scanning would be far simpler than if this is not (in which case some form of hybrid method or entirely new scanning modality would have to be developed). This issue appears to form a potentially well-defined research question that could be pursued. Answering it would require finding a suitable model system for which ground truth (the computational functionality of target system) was known, using the scanning modality to produce imagery and then testing out various forms of interpretation on the data.



**Figure 7: WBE computational biology research cycle (based on (Takahashi, Yugi et al. 2002)). WBE introduces large-scale scanning and simulation into the cycle.**

**Developing the right research cycle.** The computational biology research cycle today involves wet experiments providing cellular data and hypotheses, which drive qualitative modelling. This modelling in turn is used in quantitative modelling, which using simulations generate data that can be analysed and employed to refine the models, compare with the experiments, and suggest new experiments (Takahashi, Yugi et al., 2002). The WBE paradigm incorporates this research cycle (especially in the software modelling part), but includes two new factors. One is large-scale scanning and processing of brain tissue, providing massive amounts of data as input to the cycle, but also requiring the models to guide the development of scanning methods. The second is the large-scale data driven simulations that do not aim at producing just hypothesis testing and model refinement, but also at accurately mimicking the wet system. Both factors will increase and change the demands for data management, hypothesis searching and simulation analysis/interpretation. They will also introduce sociological and interdisciplinary factors, as different academic disciplines with very different methodologies will have to learn how to communicate and cooperate. In order to be viable, field research methods of testing, data-sharing, validation, and standards for what constitutes a result must be developed so that the extended cycle provides incentives for all participants to cooperate and push the technology forward. This is closely linked to the likely move

towards large-scale neuroscience, where automated methods will play an increasingly prominent role as they have done in genomics.



**Figure 8: *Caenorhabditis elegans*, a popular model organism with a fully mapped 302 neuron nervous system.**

**Selection of suitable model systems.** Selecting the right targets for scanning and modelling will have to take into account existing knowledge, existing research communities, likelihood of funding and academic impact as well as practical factors. While the *C. elegans* nervous system has been completely mapped (White, Southgate et al., 1986), we still lack detailed electrophysiology, likely because of the difficulty of investigating the small neurons. Animals with larger neurons may prove less restrictive for functional and scanning investigation but may lack sizeable research communities. Molluscs such as freshwater snails and insects such as fruit flies may be promising targets. They have well characterised brains, existing research communities and neural networks well within current computational capabilities.

Similarly, the selection of subsystems of the brain to study requires careful consideration. Some neural systems are heavily studied (cortical columns, the visual system, the hippocampus) and better data about them would be warmly received by the research community, yet the lack of characterization of their inputs, outputs and actual function may make development of emulation methods very hard. One system that may be very promising is the retina, which has an accessible geometry, is well studied and somewhat well understood, is not excessively complex, and better insights into which would be useful to a wide research community. Building on retinal models, models of the lateral geniculate nucleus and visual cortex may be particularly useful, since they would both have relatively well-defined inputs from the previous stages.

**At what point will the potential be clear enough to bring major economic actors into WBE?**

Given the potentially huge economic impact of human WBE (Hanson, 1994, 2008a, 2004, 2008b), if the field shows sufficient promise, major economic actors will become interested in funding and driving the research as an investment. It is unclear how far advanced the field would need to be in order to garner this attention. Solid demonstrations of key technologies are likely required, as well as a plausible path towards profitable WBE. The impact of funding on progress will depend on the main remaining bottlenecks and their funding elasticity. If scanning throughput or computer power is the limiting factor, extra funding can relatively easily scale up facilities. By contrast, limitations in neuroscience understanding are less responsive to investment. If funding arrives late, when the fundamental problems have already been solved, the amplified resources would be used to scale up pre-existing small-scale demonstration projects.

Intellectual property constitutes another important consideration for commercial funding: what could early developers own, how secure and long-term would their investment be? Without solid prospects of having preferential ownership of what it develops, a firm is unlikely to pursue the project.

## Alternative pathways

**Special hardware for WBE.** It is possible that WBE can be achieved more efficiently using dedicated hardware rather than generic hardware. Such performance gains are possible if, for example, there is a close mapping between the hardware and the brain, or if the functions of the emulation software could be implemented efficiently physically. Developing such dedicated hardware would be costly unless other applications existed (which is why interest in dedicated neural network chips peaked in the early 1990's).

Dedicated neural network chips have reached up to 1.7 billion synaptic updates (and 337 million synaptic adjustments) per second for ANN models (Kondo, Koshiba et al., 1996), which is approaching current supercomputing speeds for more complex models. Recently, there has been some development of FPGAs (Field-Programmable Gate Arrays) for running complex neuron simulations, producing an order of magnitude faster simulation for a motoneuron than a software implementation (four times real-time, 8M compartments/s) (Weinstein and Lee, 2005). A FPGA implementation has the advantage of being programmable, not requiring WBE-special purpose hardware. Another advantage include that as long as there is chip space, more complex models do not require more processing time and that precision can be adjusted to suit the model and reduce space requirements. However, scaling up to large and densely interconnected networks will require developing new techniques (Weinstein and Lee, 2006). A better understanding of the neocortical architecture may serve to produce hardware architectures that fit it well (Daisy project, 2008). It has been suggested that using FPGAs could increase computational speeds in network simulations by up to two orders of magnitude, and in turn enable testing grounds for developing special purpose WBE chips (Markram, 2006).

It may also be possible to use embedded processor technology to manufacture large amounts of dedicated hardware relatively cheaply. A study of high resolution climate modelling in the petaflop range found a 24- to 34-fold reduction of cost and about two orders of magnitude smaller power requirements using a custom variant of embedded processor chips (Wehner, Oliker et al., 2008).

This roadmap is roughly centred on the assumption that scanning technology will be similar to current microscopy, developed for large-scale neuroscience, automated sectioning of fixated tissue and local image-to-model conversion. For reasons discussed in the scanning section, non-destructive scanning of living brains appears to be hard compared to the "slice-and-dice" approach where we have various small-scale existence proofs. However, as pointed out by Robert Freitas Jr., **nanomedical techniques could possibly enable non-destructive scanning by use of invasive measurement devices**. Even if such devices prove infeasible, molecular nanotechnology could likely provide many **new scanning methodologies** as well as radical improvement of neuroscientific research methods and the efficiency of many roadmap technologies. Even far more modest developments such as single molecule analysis, nanosensors, artificial antibodies and nanoparticles for imaging (which are expected to be in use by 2015 (Nanoroadmap Project, 2006)) would have an important impact. Hence early or very successful nanotechnology would offer faster and alternative routes to achieve the

roadmap. Analysing the likelihood, timeframe, and abilities of such nanomedicine is outside the scope of this document.

One possible scanning alternative not examined much here is **high resolution scanning of frozen brains using MRI**. This might be a complement to destructive scanning, but could possibly gain enough information to enable WBE. However, we currently have little information on the limits and possibilities of the technique (see discussion in Appendix E: Non-destructive and gradual replacement).

As discussed in the overview, WBE does not assume any need for high-level understanding of the brain or mind. In fact, should such understanding be reached it is likely that it could be used to produce **artificial intelligence** (AI). Human-level AI (or superintelligent AI) would not necessarily preclude WBE, but some of the scientific and economic reasons would vanish, possibly making the field less relevant. On the other hand, powerful AI could greatly accelerate neuroscience advances and perhaps help develop WBE for other purposes. Conversely, success in some parts of the WBE endeavour could help AI, for example if cortical microcircuitry and learning rules could be simulated efficiently as a general learning/behaviour system.

**The impact and development of WBE will depend on which of the main capabilities (scanning, interpretation, simulation) develop last.** If they develop relatively independently it would be unlikely for all three to mature enough to enable human-level emulations at the same time. If computing power is the limiting factor, increasingly complex animal emulations are likely to appear. Society has time to adapt to the prospect of human-level WBE in the near future. If scanning resolution, image interpretation, or neural simulation is the limiting factor, a relatively sudden breakthrough is possible: there is enough computing power, scanning technology, and software to go rapidly from simple to complex organisms, using relatively small computers and projects. This could lead to a surprise scenario wherein society has little time to consider the possibility of human-level WBE. If computing power is the limiting factor, or if scanning is the bottleneck due to lack of throughput, then the pace of development would likely be economically determined: if enough investment were made, WBE could be achieved rapidly. This would place WBE enablement under political or economical control to a greater degree than in the alternative scenarios.

## Related technologies and spin-offs

The technologies needed to achieve WBE include the ability to scan organic tissue on a low level, interpret the findings into functional models, and run extremely large-scale simulations. WBE also requires sufficient knowledge of low-level neural function.

The desire for running extremely large simulations has been a strong motivator for **supercomputing**. Applications in nanotechnology, virtual reality, cryptography, signal processing, mathematics, genomics, and simulation of transportation, societies, business, physics, biology, and climate science will require petaflops performance in the next decade. It is unlikely that this will be the end, and exaflop performance is already being discussed in the supercomputing community. However, scaling up current architectures to the exascale may be problematic, and may require new ways of thinking about how to manage complex concurrent systems. These will to a large degree be shaped by the problems the computers are intended to solve (and the relative ranking of these problems by society, affecting

funding) as well as by tradeoffs between performance with price, energy requirements<sup>3</sup>, and other constraints. The related area of very **large-scale information storage** is also a key issue for WBE.

An obvious related technology is the creation of **virtual body models for use in medicine**. They can be used as training and study objects, or, at a more advanced stage, as personal medical models. Such models might enable doctors to investigate the current state of the patient, compare it to previous data, test or optimise various forms of simulated treatment, train particular surgical approaches, etc. This is a technology of significant practical importance that is driven by current advances in medical imaging, the personalisation of healthcare, and improving physiological models. While most current models are either static datasets or high-level physiological models, personalisation requires developing methods of physiological parameter estimation from the data. Simulation will promote the development of more realistic body models usable for WBE. Conversely, the WBE focus on data-driven bottom-up simulation appears to fit in with developing personalised biochemical and tissue models.

**Virtual test animals**, if they could be developed to a sufficient degree of realism, would be high in demand as faster and less expensive testing grounds for biomedical hypotheses (Michelson and Cole, 2007; Zheng, Kreuwel et al., 2007). They may perhaps also be a way of avoiding the ethical controversies surrounding animal testing (although it is not inconceivable that concerns about animal welfare would in time be extended to emulated animals). This could provide an impetus for the development of organism emulation techniques and especially validation methods that help guarantee that the virtual animals have the same properties as real animals would.

Overall, there is increasing interest and capability in **quantitative modelling of biology** (Di Ventura, Lemerle et al., 2006). While much effort has gone into metabolic or control networks of particular interest, there is a push towards cell models encompassing metabolism, the genome and proteomics (Ortoleva, Berry et al., 2003; Tomita, 2001; Schaff, Slepchenko et al., 2001; Tyson, 2001). There is also interest in building simulators for modelling self-assembly in subcellular systems (Ortoleva, Berry et al., 2003). Besides predicting biological responses and helping to understand biology, modelling will likely become important for synthetic biology (Serrano, 2007).

In order to produce realistic virtual stimuli for a brain emulation, accurate simulations of the sensory input to the brain are needed. The same techniques used to investigate neural function can be applied to the senses. It has also been proposed that technology to record normal neural activity along the brain nerves and spinal cord could be helpful. Such data, for example recorded using massively parallel electrode arrays or nanoimplants, would provide good test data to validate a body model. Recorded sensory data would also be repeatable, enabling comparisons between different variants of the same emulation. Neural interfacing is also useful for developing better robotic body models. Currently, most interest in **neural interfaces** is focused on helping people with disabilities use sensory or motoric prosthetics. While neural interfacing for enhancement purposes is possible, it is unlikely to become a significant driver until prosthetic systems have become cheap, safe, and very effective.

---

<sup>3</sup> An exascale computer using 2008 technology would require tens of megawatts (Sandia National Laboratories, 2008).

# Issues

## Emulation systems

A functioning brain emulation will include, in addition to the brain model (the main part), some way for the brain model to experience bodily interactions with an environment. There are two different ways in which this could be accomplished: via a simulated virtual body inhabiting a virtual reality (which can be linked to the outside world); or via a hardware body connected to the brain model via a body interface module.

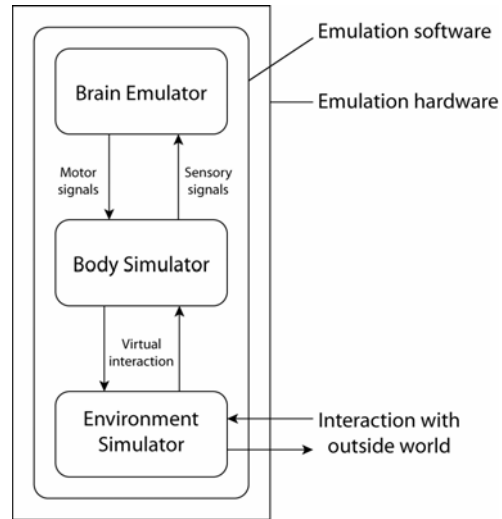
Entry-level WBE does not require the capacity to accommodate all of the original sensory modalities or to provide a fully naturalistic body experience. Simulated bodies and worlds, or

hardware body interfaces, as well as communications with the outside world, are not necessary *per se* for brain emulation except insofar they are needed to maintain short-term function of the brain. For long-term function, especially of human mind emulations, embodiment and communication are important. Sensory or motor deprivation appears to produce intellectual and perceptual deficits within a few days time (Zubek and Macneill, 1966).

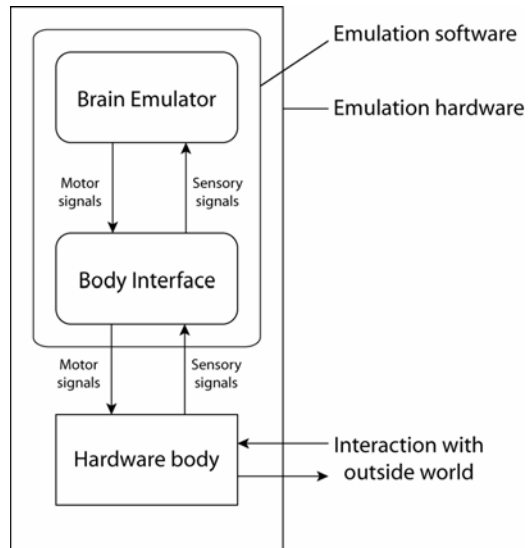
The brain emulator performs the actual emulation of the brain and closely linked subsystems such as brain chemistry. The result of its function is a series of states of emulated brain activity. The emulation produces and receives neural signals corresponding to motor actions and sensory information (in addition, some body state information such as glucose levels may be included).

The body simulator contains a model of the body and its internal state. It produces sensory signals based on the state of the body model and the environment, sending them to the brain emulation. It converts motor signals to muscle contractions or direct movements in the body model. The degree to which different parts of the body require accurate simulation is likely variable.

The environment simulator maintains a model of the surrounding environment, responding to actions from the body model and sending back simulated sensory information. This is also



**Figure 9: Emulation system for completely virtual emulation.**



**Figure 10: Emulation system for embodied emulations.**

the most convenient point of interaction with the outside world. External information can be projected into the environment model, virtual objects with real world affordances can be used to trigger suitable interaction etc.

The overall emulation software system (the “exoself” to borrow Greg Egan’s term) would regulate the function of the simulators and emulator, allocate computational resources, collect diagnostic information, provide security (e.g. backups, firewalls, error detection, encryption) and so on. It could provide software services to emulated minds (accessed through the virtual environment) and/or outside experimenters.

A variant of the above system would be an embodied brain emulation, in which case the body simulator would merely contain the translation functions between neural activity and physical signals, and these would then be actuated using a hardware body. The body might be completely artificial (in which case motor signals have to be mapped onto appropriate body behaviours) or biological but equipped with nerve-computer interfaces enabling sensing and control. The computer system running the emulation does not have to be physically present in the body.

It is certainly possible to introduce signals from the outside on higher levels than in a simulated or real body. It would be relatively trivial to add visual or auditory information directly to the body model and have them appear as virtual or augmented reality. Introducing signals directly into the brain emulation would require them to make sense as neural signals (e.g. brain stimulation or simulated drugs). “Virtual brain-computer interfaces” with perfect clarity and no risk of side effects could be implemented as extensions of the body simulation/interface.

If computing power turns out to be a bottleneck resource, then early emulations are likely to run more slowly than the biological system they aim at emulating. This would limit the ability of the emulations to interact in real-time with the physical world. In distributed emulations delays between computing nodes put a strong limit on how fast they can become. The shortest delay using 100 m/s axons across the brain is about 1 ms. Assuming light speed communication, processing nodes cannot be further away than 300 km if longer delays are to be avoided.

## **Complications and exotica**

Beside straight neural transmission through synapses there may be numerous other forms of information processing in the brain that may have to be emulated. How important they are for success in emulation remains uncertain. An important application of early brain emulations and their precursors will be to enable testing of their influence.

## **Spinal cord**

While traditionally the vertebrate spinal cord is often regarded as little more than a bundle of motor and sensor axons together with a central column of stereotypical reflex circuits and pattern generators, there is evidence that the processing may be more complex (Berg, Alaburda et al., 2007) and that learning processes occur among spinal neurons (Crown, Ferguson et al., 2002). The networks responsible for standing and stepping are extremely flexible and unlikely to be hardwired (Cai, Courtine et al., 2006).

This means that emulating just the brain part of the central nervous system will lose much body control that has been learned and resides in the non-scanned cord. On the other hand, it is possible that a generic spinal cord network would, when attached to the emulated brain, adapt (requiring only scanning and emulating one spinal cord, as well as finding a way of attaching the spinal emulation to the brain emulation). But even if this is true, the time taken may correspond to rehabilitation timescales of (subjective) months, during which time the simulated body would be essentially paralysed. This might not be a major problem for personal identity in mind emulations (since people suffering spinal injuries do not lose personal identity), but it would be a major limitation to their usefulness and might limit development of animal models for brain emulation.

A similar concern could exist for other peripheral systems such as the retina and autonomic nervous system ganglia.

The human spinal cord weighs 2.5% of the brain and contains around  $10^{-4}$  of the number of neurons in the brain (13.5 million neurons). Hence adding the spinal cord to an emulation would add a negligible extra scan and simulation load.

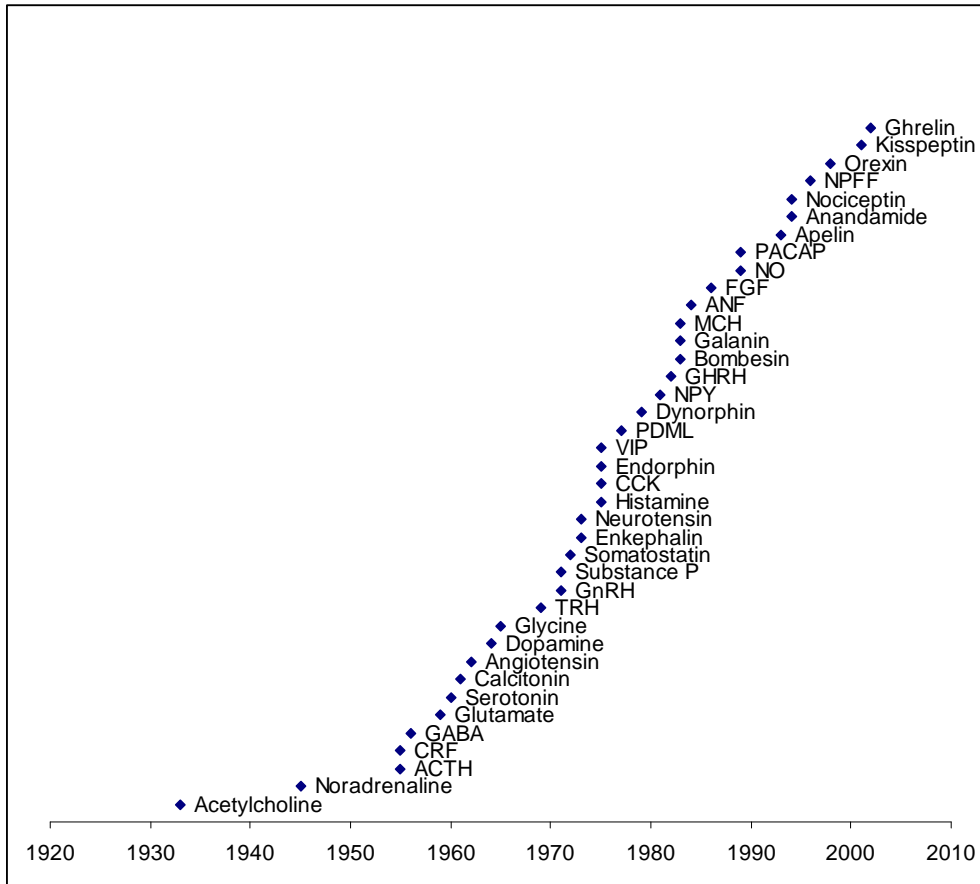
### **Synaptic adaptation**

Synapses are usually characterized by their “strength”, the size of the postsynaptic potential they produce in response to a given magnitude of incoming excitation. Many (most?) synapses in the CNS also exhibit depression and/or facilitation: a temporary change in release probability caused by repeated activity (Thomson, 2000). This rapid dynamics likely plays a role in a variety of brain functions, such as temporal filtering (Fortune and Rose, 2001), auditory processing (Macleod, Horiuchi et al., 2007) and motor control (Nadim and Manor, 2000). These changes occur on timescales longer than neural activity (tens of milliseconds) but shorter than long-term synaptic plasticity (minutes to hours). Adaptation has already been included in numerous computational models. The computational load is usually 1-3 extra state variables in each synapse.

### **Unknown neurotransmitters and neuromodulators**

Not all neuromodulators are known. At present about 10 major neurotransmitters and 200+ neuromodulators are known, and the number is increasing. (Thomas, 2006) lists 272 endogenous extracellular neuroactive signal transducers with known receptors, 2 gases, 19 substances with putative or unknown binding sites and 48 endogenous substances that may or may not be neuroactive transducers (many of these may be more involved in general biochemical signalling than brain-specific signals). Plotting the year of discovery for different substances (or families of substances) suggests a linear or possibly sigmoidal growth over time (Figure 11).





**Figure 11: Time of discovery of the neurotransmitter or neuromodulator activity of a number of substances or families of substances. Data taken from (von Bohlen und Halbach and Dermietzel 2006), likely underrepresenting the development after 2000.**

An upper bound on the number of neuromodulators can be found using genomics. About 800 G-protein coupled receptors can be found in the human genome, of which about half were sensory receptors. Many are “orphans” that lack known ligands, and methods of “deorphanizing” receptors by expressing them and determining what they bind to have been developed. In the middle 1990’s about 150 receptors had been paired to 75 transmitters, leaving around 150-200 orphans in 2003 (Wise, Jupe et al., 2004). At present, 7-8 receptors are deorphanized each year (von Bohlen und Halbach and Dermietzel, 2006); at this rate all orphans should be adopted within  $\approx 20$  years, leading to the discovery of around 50 more transmitters (Civelli, 2005).

Similarly guanylyl cyclase-coupled receptors (four orphans, (Wedel and Garbers, 1998)), tyrosine kinase-coupled receptors ( $\ll 100$ , (Muller-Tidow, Schwable et al., 2004)) and cytokine receptors would add a few extra transmitters.

However, there is room for some surprises. Recently it was found that protons were used to signal in *C. elegans* rhythmic defecation (Pfeiffer, Johnson et al., 2008) mediated using a  $\text{Na}^+/\text{H}^+$  exchanger, and it is not inconceivable that similar mechanisms could exist in the brain. Hence the upper bound on all transmitters may be set by not just receptors but also by membrane transporter proteins.

For WBE modelling all modulatory interactions is probably crucial, since we know that neuromodulation does have important effects on mood, consciousness, learning and perception. This means not just detecting their existence but to create quantitative models of these interactions, a sizeable challenge for experimental and computational neuroscience.

### **Unknown ion channels**

Similar to receptors, there are likely unknown ion channels that affect neuron dynamics.

The Ligand Gated Ion Channel Database currently contains 554 entries with 71 designated as channel subunits from *Homo sapiens* (EMBL-EBI, 2008; Donizelli, Djite et al., 2006). Voltage gated ion channels form a superfamily with at least 143 genes (Yu, Yarov-Yarovoy et al., 2005). This diversity is increased by multimerization (combinations of different subunits), modifier subunits that do not form channels on their own but affect the function of channels they are incorporated into, accessory proteins as well as alternate mRNA splicing and post-translational modification (Gutman, Chandy et al., 2005). This would enable at least an order of magnitude more variants.

Ion channel diversity increases the diversity of possible neuron electrophysiology, but not necessarily in a linear manner. See the discussion of inferring electrophysiology from gene transcripts in the interpretation chapter.

### **Volume transmission**

Surrounding the cells of the brain is the extracellular space, on average 200 Å across and corresponding to 20% of brain volume (Nicholson, 2001). It transports nutrients and buffers ions, but may also enable volume transmission of signalling molecules.

Volume transmission of small molecules appears fairly well established. Nitrous oxide is hydrophobic and has low molecular weight and can hence diffuse relatively freely through membranes: it can reach up to 0.1-0.2 mm away from a release point under physiological conditions (Malinski, Taha et al., 1993; Schuman and Madison, 1994; Wood and Garthwaite, 1994). While mainly believed to be important for autoregulation of blood supply, it may also have a role in memory (Ledo, Frade et al., 2004). This might explain how LTP (Long Term Potentiation) can induce “crosstalk” that reduces LTP induction thresholds over a span of 10 µm and ten minutes (Harvey and Svoboda, 2007).

Signal substances such as dopamine exhibit volume transmission (Rice, 2000) and this may have effect for potentiation of nearby synapses during learning: simulations show that a single synaptic release can be detected up to 20 µm away and with a 100 ms half-life (Cragg, Nicholson et al., 2001). Larger molecules have their relative diffusion speed reduced by the limited geometry of the extracellular space, both in terms of its tortuosity and its anisotropy (Nicholson, 2001). As suggested by Robert Freitas, there may also exist active extracellular transport modes. Diffusion rates are also affected by local flow of the CSF and can differ from region to region (Fenstermacher and Kaye, 1988); if this is relevant then local diffusion and flow measurements may be needed to develop at least a general brain diffusion model. The geometric part of such data could be relatively easily gained from the high resolution 3D scans needed for other WBE subproblems.

Rapid and broad volume transmission such as from nitrous oxide can be simulated using a relatively coarse spatiotemporal grid size, while local transmission requires a grid with a spatial scale close to the neural scale if diffusion is severely hindered.

For constraining brain emulation it might be useful to analyse the expected diffusion and detection distances of the  $\approx 200$  known chemical signalling molecules based on their molecular weight, diffusion constant and uptake (for different local neural geometries and source/sink distributions). This would provide information on diffusion times that constrain the diffusion part of the emulation and possibly show which chemical species need to be spatially modelled.

## **Body chemical environment**

The body acts as an input/output unit that interacts with our perception and motor activity. It also acts as a chemical environment that affects the brain through nutrients, hormones, salinity, dissolved gases, and possibly immune signals. Most of these chemical signals occur on a subconscious level and only become apparent when they influence e.g. hypothalamus to produce hunger or thirst sensations. For brain emulation, some aspects of this chemical environment has to be simulated.

This would require mapping the human metabolome, at least in regards to substances that cross the blood-brain barrier. The metabolome is likely on the order of 2,000-2,500 compounds (Beecher, 2003; Wishart, Tzur et al., 2007) and largely does not change more rapidly than on the second-timescale. This suggests that compared to the demands of the WBE, the body chemistry model, while involved, would be relatively simple.

If a protein interaction model is needed rather than metabolism, then complexity increases. According to one estimate the human interactome is around  $\approx 650,000$  protein-protein interactions (Stumpf, Thorne et al., 2008).

## **Neurogenesis and remodelling**

Recent results show that neurogenesis persists in some brain regions in adulthood, and might have nontrivial functional consequences (Saxe, Malleret et al., 2007). During neurite outgrowth, and possibly afterwards, cell adhesion proteins can affect gene expression and possible neuron function by affecting second messenger systems and calcium levels (Crossin and Krushel, 2000). However, neurogenesis is mainly confined to discrete regions of the brain and does not occur to a great extent in adult neocortex (Bhardwaj, Curtis et al., 2006).

Since neurogenesis occurs on fairly slow timescales ( $> 1$  week) compared to brain activity and normal plasticity, it could probably be ignored in brain emulation if the goal is an emulation that is intended to function faithfully for only a few days and not to exhibit truly long-term memory consolidation or adaptation.

A related issue is remodelling of dendrites and synapses. Over the span of months dendrites can grow, retract and add new branch tips in a cell type-specific manner (Lee, Huang et al., 2006). Similarly synaptic spines in the adult brain can change within hours to days, although the majority remain stable over multi-month timespans (Grutzendler, Kasthuri et al., 2002; Holtmaat, Trachtenberg et al., 2005; Zuo, Lin et al., 2005). Even if neurogenesis is ignored and the emulation is of an adult brain, it is likely that such remodelling is important to learning and adaptation.

Simulating stem cell proliferation would require data structures representing different cells and their differentiation status, data on what triggers neurogenesis, and models allowing for the gradual integration of the cells into the network. Such a simulation would involve modelling the geometry and mechanics of cells, possibly even tissue differentiation. Dendritic and synaptic remodelling would also require a geometry and mechanics model. While technically involved and requiring at least a geometry model for each dendritic compartment the computational demands appear small compared to neural activity.

## **Glia cells**

Glia cells have traditionally been regarded as merely supporting actors to the neurons, but recent results suggest that they may play a fairly active role in neural activity. Beside the important role of myelinization for increasing neural transmission speed, at the very least they have strong effects on the local chemical environment of the extracellular space surrounding neurons and synapses.

Glial cells exhibit calcium waves that spread along glial networks and affect nearby neurons (Newman and Zahs, 1998). They can both excite and inhibit nearby neurons through neurotransmitters (Kozlov, Angulo et al., 2006). Conversely, the calcium concentration of glial cells is affected by the presence of specific neuromodulators (Perea and Araque, 2005). This suggests that the glial cells acts as an information processing network integrated with the neurons (Fellin and Carmignoto, 2004). One role could be in regulating local energy and oxygen supply.

If glial processing turns out to be significant and fine-grained, brain emulation would have to emulate the glia cells in the same way as neurons, increasing the storage demands by at least one order of magnitude. However, the time constants for glial calcium dynamics is generally far slower than the dynamics of action potentials (on the order of seconds or more), suggesting that the time resolution would not have to be as fine, making the computational demands increase far less steeply.

## **Ephaptic effects**

Electrical effects may also play a role via so called “ephaptic transmission”. In a high resistance environment, currents from action potentials are forced to flow through neighbouring neurons, changing their excitability. It has been claimed that this process constitutes a form of communication in the brain, in particular the hippocampus (Krnjevic, 1986). However, in most parts of the brain there is a large extracellular space and blocking myelin, so even if ephaptic interactions play a role, they do so only locally, e.g. in the olfactory system (Bokil, Laaris et al., 2001), dense demyelinated nerve bundles (Reutskiy, Rossoni et al., 2003), or trigeminal pain syndromes (Love and Coakham, 2001). It should be noted that the nervous system appears relatively insensitive to everyday external electric fields (Valberg, Kavet et al., 1997; Swanson and Kheifets, 2006).

If ephaptic effects were important, the emulation would need to take the locally induced electromagnetic fields into account. This would plausibly involve dividing the extracellular space (possibly also the intracellular space) into finite elements where the field can be assumed to be constant, linear or otherwise easily approximable. The cortical extracellular length constant is on order of  $\approx 100 \mu\text{m}$  (Gardner-Medwin, 1983), which would necessitate on the order of  $1.4 \cdot 10^{12}$  such compartments if each compartment is 1/10 of the length constant.

Each compartment would need at least two vector state variables and 6 components of a conductivity tensor; assuming one byte for each, the total memory requirements would be on the order of 10 terabytes. Compared to estimates of neural simulation complexity, this is relatively manageable. The processing needed to update these compartments would be on the same order as a detailed compartment model of every neuron and glia cell.

## **Dynamical state**

The methods for creating the necessary data for brain emulation discussed in this paper deal with just the physical structure of the brain tissue, not its state of activity. Some information such as working memory may be stored just as ongoing patterns of neural excitation and would be lost. Similarly, information in calcium concentrations, synaptic vesicle depletion, and diffusing neuromodulators may be lost during scanning. A likely consequence would be amnesia of the time closest to the scanning.

However, loss of brain activity does not seem to prevent the return of function and personal identity. This is demonstrated by the reawakening of coma patients, and by cold water near-drowning cases in which brain activity temporarily ceased due to hypothermia (Elixson, 1991).

## **Quantum computation**

While practically all neuroscientists subscribe to the dogma that neural activity is a phenomenon that occurs on a classical scale, there have been proposals (mainly from physicists) that quantum effects play an important role in the function of the brain (Penrose, 1989; Hameroff, 1987). So far there is no evidence for quantum effects in the brain beyond quantum chemistry, and no evidence that such effects play an important role for intelligence or consciousness (Litt, Eliasmith et al., 2006). There is no lack of possible computational primitives in neurobiology nor any phenomena that appear unexplainable in terms of classical computations (Koch and Hepp, 2006). Quantitative estimates for decoherence times for ions during action potentials and microtubules suggest that they decohere on a timescale of  $10^{-20}$  –  $10^{-13}$  s, about ten orders of magnitude faster than the normal neural activity timescales. Hence quantum effects are unlikely to persist long enough to affect processing (Tegmark, 2000). This, however, has not deterred supporters of quantum consciousness, who argue that there may be mechanisms protecting quantum superpositions over significant periods (Rosa and Faber, 2004; Hagan, Hameroff et al., 2002).

If these quantum-mind hypotheses were true, brain emulation would be significantly more complex, but not impossible given the right (quantum) computer. In (Hameroff, 1987) mind emulation is considered based on quantum cellular automata, which in turn are based on the microtubule network that the author suggests underlies consciousness.

Assuming 7.1 microtubules per square  $\mu\text{m}$  and 768.9  $\mu\text{m}$  in average length (Cash, Aliev et al., 2003) and that 1/30 of brain volume is neurons (although given that microtubuli networks occurs in all cells, glia – and any other cell type! – may count too) gives  $10^{16}$  microtubules. If each stores just a single quantum bit this would correspond to a  $10^{16}$  qubit system, requiring a physically intractable  $2^{10^{16}}$  bit classical computer to emulate. If only the microtubules inside a cell act as a quantum computing network, the emulation would have to include  $10^{11}$  connected 130,000 qubit quantum computers. Another calculation, assuming merely classical computation in microtubules, suggests  $10^{19}$  bytes per brain operating at  $10^{28}$  FLOPS (Tuszynski, 2006). One problem with these calculations is that they impute such a profoundly

large computational capacity at a subneural level that a macroscopic brain seems unnecessary (especially since neurons are metabolically costly).

## **Analog computation**

A surprisingly common doubt expressed about the possibility of simulating even simple neural systems is that they are analog rather than digital. The doubt is based on the assumption that there is an important qualitative difference between continuous and discrete variables.

If computations in the brain make use of the full power of continuous variables the brain may essentially be able to achieve “hypercomputation”, enabling it to calculate things an ordinary Turing machine cannot (Ord, 2006; Siegelmann and Sontag, 1995). See (Zenil and Hernandez-Quiroz, 2007) for a review of how different brain computational architectures would enable different levels of computational power, and the requirements for neural networks to simulate these.

However, brains are made of imperfect structures which are, in turn, made of discrete atoms obeying quantum mechanical rules forcing them into discrete energy states, possibly also limited by a space-time that is discrete on the Planck scale (as well as noise, see below) and so it is unlikely that the high precision required of hypercomputation can be physically realized (Eliasmith, 2001). Even if hypercomputation were physically possible, it would by no means be certain that it is used in the brain, and it might even be difficult to detect if it were (the continual and otherwise hard to explain failure of WBE would be some evidence in this direction). However, finding clear examples of non-Turing computable abilities of the mind would be a way of ruling out Turing emulation.

A discrete approximation of an analog system can be made arbitrarily exact by refining the resolution. If an  $M$  bit value is used to represent a continuous signal, the signal-to-noise ratio is approximately  $20 \log_{10}(2^M)$  dB (assuming uniform distribution of discretization errors, which is likely for large  $M$ ). This can relatively easily be made smaller than the natural noise sources such as unreliable synapses, thermal, or electrical noise. The thermal noise is on the order of  $4.2 \cdot 10^{-21}$  J, which suggests that energy differences smaller than this can be ignored unless they occur in isolated subsystems or on timescales fast enough to not thermalize. Field potential recordings commonly have fluctuations on the order of millivolts due to neuron firing and a background noise on the order of tens of microvolts. Again this suggests a limit to the necessary precision of simulation variables<sup>4</sup>.

## **Determinism**

A somewhat related criticism is the assumed determinism of computers, while the brain is assumed either to contain true randomness or a physically indeterministic element (often declared to be “free will”).

The randomness version of the determinism criticism can be met by including sufficient noise in the simulation. Random events may play a role in the function of the nervous system. In particular, the number of individual molecules involved in transcription regulation of some proteins and in the function of synaptic spines is low enough that individual random interactions can affect whether a gene is switched on or whether a phosphorylation cascade

---

<sup>4</sup> Analog computation may still be a useful hardware paradigm under some conditions.

happens. This randomness may have biological importance, and is sometimes included in biophysical models. Another possible role of noise might be stochastic resonance, where noise acts to increase the signal-to-noise ratio in nonlinear (and information-theoretically suboptimal) systems attempting to detect a weak periodic input (Gammaitoni, Hanggi et al., 1998). It has been demonstrated in mechanoreceptors (Douglass and Wilkens, 1998) and various other forms of sensory systems (Douglass and Wilkens, 1998) as a way of detecting faint signals. However, while the exact spectral distribution and power may matter for an emulation, it does not seem that the resonance effect would be disrupted by using pseudorandom noise if the recurrence time is long enough. Unless there are some important “hidden variables” in the noise of the brain, noise can be easily approximated using a suitably long-periodic random number generator (Tegmark, 2000) or even by means of an attached physical random number generator using quantum mechanics (Stefanov, Gisin et al., 2000). Randomness is therefore highly unlikely to pose a major obstacle to WBE.

Hidden variables or indeterministic free will appear to have the same status as quantum consciousness: while not in any obvious way directly ruled out by current observations, there is no evidence that they occur or are necessary to explain observed phenomena.

## Summary

Table 4 shows an overview of informal estimates of the likelihood that certain features are needed for WBE and whether they would pose serious implementation problems if needed.

**Table 4: Likelihood estimates of modelling complications.**

	<b>Likelihood needed for WBE</b>	<b>Implementation problems</b>
Spinal cord	Likely	Minor. Would require scanning some extra neural tissue.
Synaptic adaptation	Very likely	Minor. Introduces extra state-variables and parameters that need to be set.
Currently unknown neurotransmitters and neuromodulators	Very likely	Minor. Similar to known transmitters and modulators.
Currently unknown ion channels	Very likely	Minor. Similar to known ion channels.
Volume transmission	Somewhat likely	Medium. Requires diffusion models and microscale geometry.
Body chemical environment	Somewhat likely	Medium. Requires metabolomic models and data.
Neurogenesis and remodelling	Somewhat likely	Medium. Requires cell mechanics and growth models.
Glia cells	Possible	Minor. Would require more simulation compartments, but likely running on a slower timescale.
Ephaptic effects	Possible	Medium. Would require relatively fine-grained EM simulation.
Dynamical state	Very unlikely	Profound. Would preclude most proposed scanning methods.
Quantum computation	Very unlikely	Profound. Would preclude currently conceived scanning methods and would require quantum computing.
Analog computation	Very unlikely	Profound. Would require analog computer hardware.
True randomness	Very unlikely	Medium to profound, depending on whether merely “true” random noise or “hidden variables” are needed.

## Scanning

The first step in brain emulation is to acquire the necessary information from a physical brain. We will call this step “scanning”.

Brain emulation for compartment models of neuron activity needs to acquire both geometric data about the localization and morphology of the nervous connections and functional/chemical data about their nature such as what ion channels, receptors, and neurotransmitters are present, the presence of electrical synapses, electrical membrane properties, phosphorylation states of synapses, and genetic expression states. This must be done at a sufficient resolution. It may be possible to infer some functional properties such as whether a synapse is excitatory or inhibitory purely from geometry (e.g., a synapse from a smooth neuron with a particular morphology is likely inhibitory). Yet it remains unclear how much information about synaptic strength and neuromodulator type can be inferred from pure geometry at a given level of resolution.

There are several potential approaches to scanning. Here we focus on destructive scanning, in which the brain is destructively disassembled during the emulation process. The process could be applied immediately after death or on cryogenically preserved brain tissue. This is the technologically simplest approach. Destructive scanning has greater freedom both in physical effects used, energy levels, and fixating the brain through freezing and/or chemical fixation. Possible alternatives include non-destructive scanning and gradual replacement; these are discussed in Appendix E.

Most methods discussed in this section require the sectioning of the brain into smaller pieces that can be accurately scanned. The sectioning methods and the handling of the tissue may pose significant problems and require the development of special handling technology. In particular, sample distortion and drift are key problems; the first requiring very careful sectioning methods, the second either high-precision equipment or embedding of fiducial markers.

### **MRI microscopy**

Although MRI imaging may not be suitable for scanning entire brains at sufficient resolution, MRI microscopy might be suitable for scanning parts of them if water diffusion is stopped by freezing or fixation.

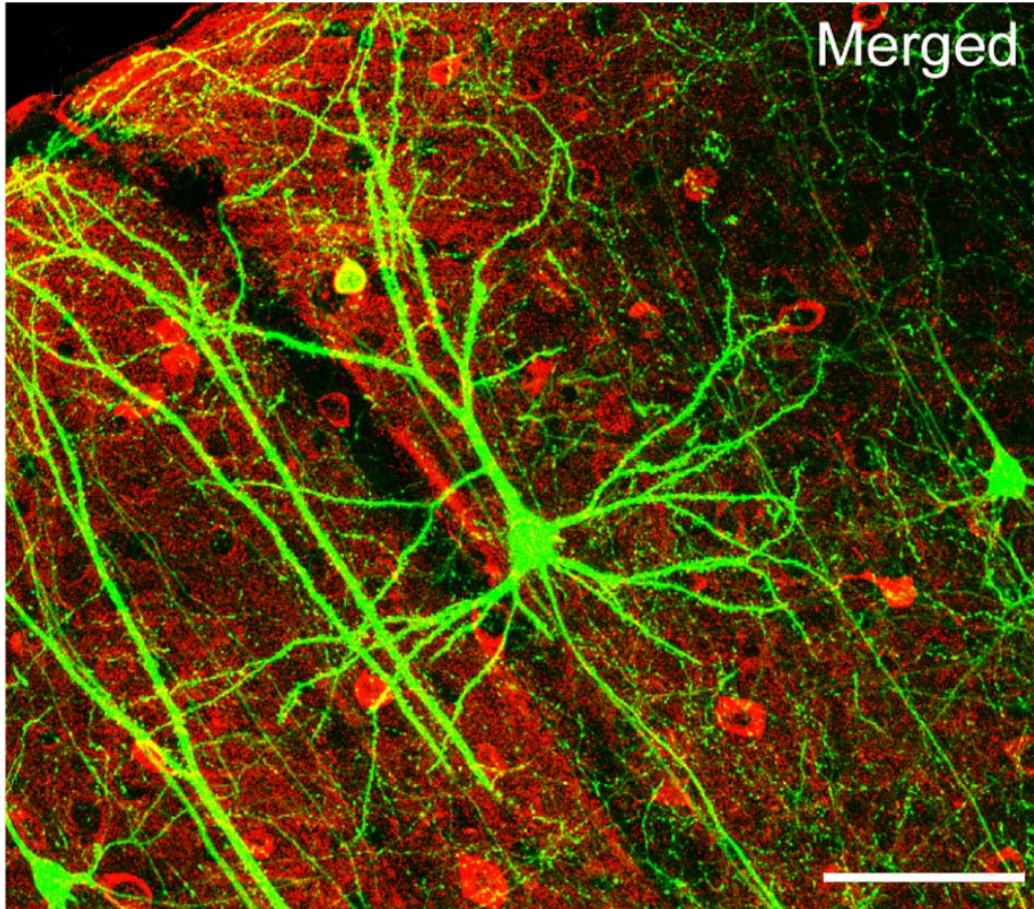
3D MR microscopy has achieved resolutions on the order of  $3.7 \times 3.3 \times 3.3 \mu\text{m}$  (Ciobanu, Seeber et al., 2002) but is limited by the small field of view and long exposure times. One way of improving the field of view may be parallelism, where an array of MRI coils is moved over the surface (McDougall and Wright, 2007).

A combination of MRI and AFM is magnetic resonance force microscopy (MRFM) where a magnetic bead is placed on an ultra thin cantilever and moved over the sample (or the reverse). By generating RF magnetic fields the spins of nuclei within the resonant slice beneath the bead can be flipped, producing forces on the cantilever that can be detected. This would enable identification of the molecules present near the surface. Current resolutions achieved are 80 nm voxels in a scan volume of  $0.5 \mu\text{m}^3$  (Chao, Dougherty et al., 2004) and single spin detection with 25 nm resolution in one dimension (Rugar, Budakian et al., 2004).



Whether this can be scaled up to detecting e.g. the presence of cell membranes or particular neurotransmitters remains to be seen.

## Optical methods



**Figure 12: Confocal microscopy picture of visual cortex neurons. Stained with GABA-channel antibody (red) and containing neurons expressing green fluorescent protein. The white scale bar is 100  $\mu\text{m}$ . (Lee, Huang et al., 2006).**

Optical microscopy methods are limited by the need for staining tissues to make relevant details stand out and the diffraction limits set by the wavelength of light ( $\approx 0.2 \mu\text{m}$ ). The main benefit is that they go well together with various spectrometric methods (see below) for determining the composition of tissues.

Sub-diffraction optical microscopy is possible, if limited. Various fluorescence-based methods have been developed that could be applicable if fluorophores could be attached to the brain tissue in a way that provided the relevant information. Structured illumination techniques use patterned illumination and post-collection analysis of the interference fringes between the illumination and sample image together with optical nonlinearities to break the diffraction limit. This way, 50 nm resolving power can be achieved in a wide field, at the price of photodamage due to the high power levels (Gustafsson, 2005). Near-field scanning optical microscopy (NSOM) uses a multinanometre optic fiber to scan the substrate using near-field optics, gaining resolution (down to the multi-nanometer scale) and freedom from using

fluorescent markers at the expense of speed and depth of field. It can also be extended into near field spectroscopy.

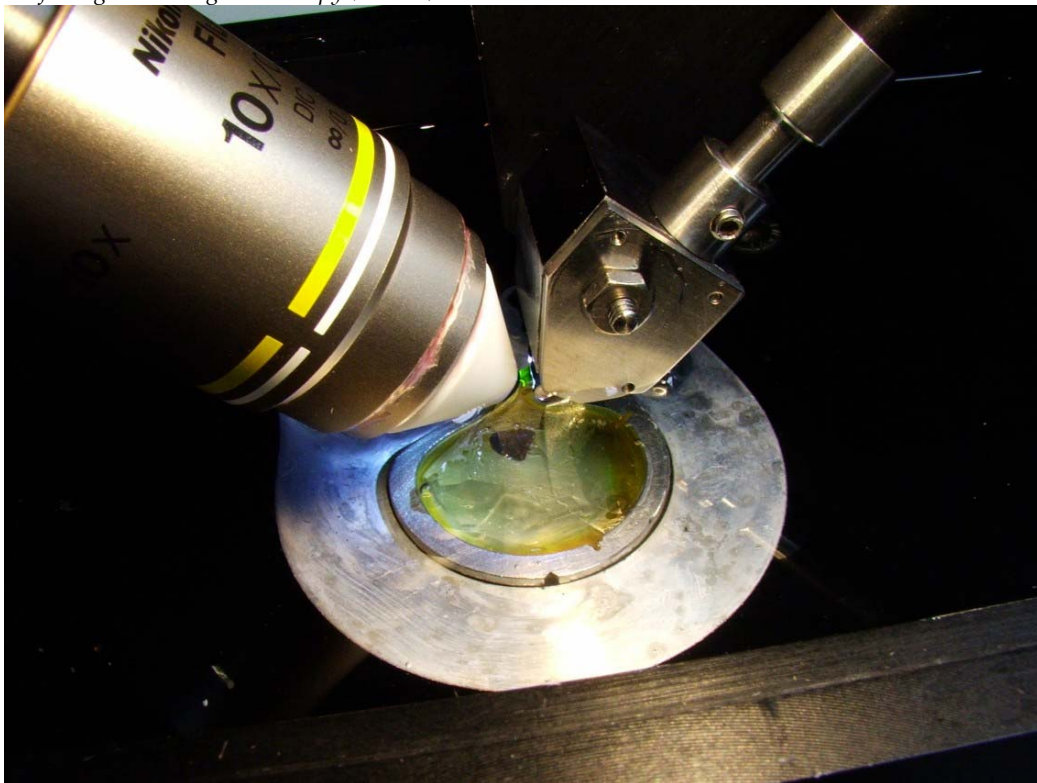
Confocal microscopy suffers from having to scan through the entire region of interest and quality degrades away from the focal plane. Using inverse scattering methods depth-independent focus can be achieved (Ralston, Marks et al., 2007).

#### *Optical histology and dissection*

All-optical histology uses femtosecond laser pulses to ablate tissue samples, avoiding the need for mechanical removal of the surface layer (Tsai, Friedman et al., 2003). This treatment appears to change the tissue 2-10  $\mu\text{m}$  from the surface. However, Tsai et al. were optimistic about being able to scan a fluorescence labelled entire mouse brain into 2 terapixels at the diffraction limit of spatial resolution.

Another interesting application of femtosecond laser pulses is microdissection (Sakakura, Kajiyama et al., 2007; Colombelli, Grill et al., 2004). The laser was able to remove 100  $\mu\text{m}$  samples from plant and animal material, modifying a  $\sim 10 \mu\text{m}$  border. This form of optical dissection might be an important complement for EM methods, in that, after scanning the geometry of the tissue at a high resolution, relevant pieces can be removed and analyzed microchemically. This could enable gaining both the EM connectivity data and detailed biochemistry information. Platforms already exist that can both inject biomolecules into individual cells, perform microdissection, isolate and collect individual cells using laser catapulting, and set up complex optical force patterns (Stuhrmann, Jahnke et al., 2006).

#### *Knife-Edge Scanning Microscopy (KESM)*



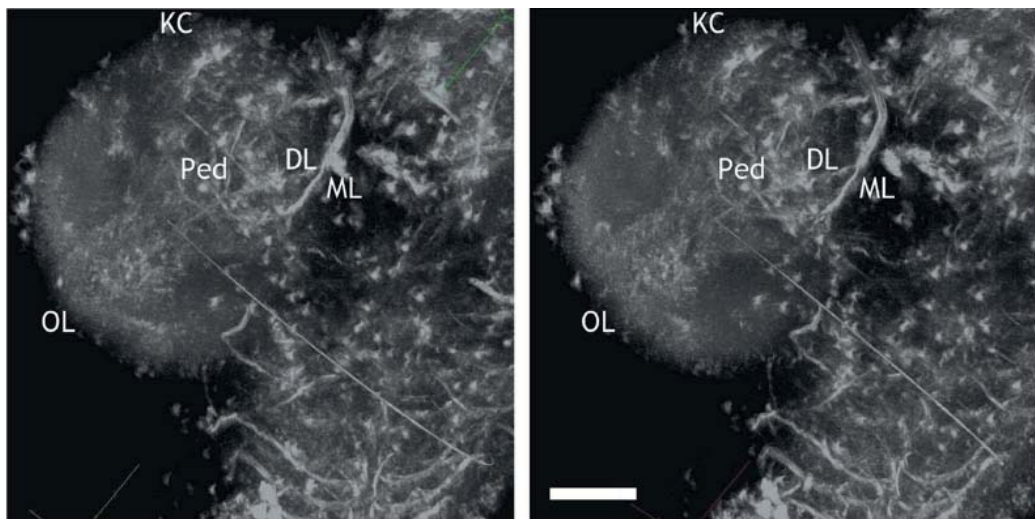
**Figure 13: Knife Edge-Scanning Microscope. Microscope objective (left), diamond knife (right) cutting the specimen in the center. Note the illumination refracted through the knife (Copyright Brain Networks Laboratory, Texas A&M University).**

KESM is a method for staining and imaging large volumes at high resolutions by integrating the sectioning and imaging step. It was developed for reconstruction and modelling of the three-dimensional anatomical structure of individual cells in situ. While having lower resolution than SBF-SEM (see below) it enables the imaging of an entire macroscopic tissue volume such as a mouse brain in reasonable time (McCormick, 2002a; McCormick, 2002b).

The KESM acts simultaneously as a microtome and a microscope. A diamond knife is used for the cutting and illumination, moving together with the microscope across a stationary tissue specimen embedded in plastic. Imaging occurs of the just-separated section along a 1D strip. Imaging at 0.3  $\mu\text{m}$  resolution of 0.5  $\mu\text{m}$  thick sections has been demonstrated, producing datasets where microvasculature and individual cells can be traced using contouring algorithms. The instrument scans at rates up to 200Mpixels/s. This would enable scanning a mouse brain ( $\approx 1 \text{ cm}^3$ ) in a hundred hours, giving a 15 terabyte dataset of uncompressed data (Mayerich, Abbott et al., 2008). The width of field is 2.5 mm for 64  $\mu\text{m}$  resolution and 0.625 mm for 32  $\mu\text{m}$  resolution (McCormick, Koh et al., 2004). In order to reduce jittering and using knives larger than the microscope field of view, the sample is cut in a stair-step manner (Koh and McCormick, 2003).

The main limitation is the need for staining inside a volume. At present the number of such stains is limited. Using transgenic animals expressing stains or fluorescence could enable mapping of different neural systems.

### X-Ray microscopy



**Figure 14: X-ray microtomography stereo image of the supraesophageal ganglion in *Drosophila*, showing individual neurons. Scale 50  $\mu\text{m}$ . (Mizutani, Takeuchi et al., 2007)**

X-ray microscopy is intermediate between optical microscopy and electron microscopy in terms of resolution.

Hard X-ray microtomography has been used to image the larval *Drosophila* brain (Mizutani, Takeuchi et al., 2007). This was achieved by staining neurons with metal and then acquiring images rotated by 0.12° with 300 ms exposure, with a total acquisition time of 1800 seconds. The field of view was on the order of 0.5  $\text{mm}^2$  with a pixel resolution of 0.47x0.47  $\mu\text{m}$ ; the resulting tomographical resolution was about 1  $\mu\text{m}$  in each direction. Individual neurons

could be identified, and the authors estimate that the setup could in principle scan a 1 mm<sup>3</sup> block of mammalian nerve tissue with 10<sup>3</sup>-10<sup>4</sup> neurons. However, the resolution is likely too crude to identify synapses and connectivity.

By using soft X-rays with wavelengths in the “water window” (between the absorption edges of oxygen and carbon at 2.3-4.4 nm) where carbon absorbs ten times as strongly as water, organic structures can be imaged with good contrast down to at least 30 nm resolution. Advantages include that it can be done without special sample preparation procedures and can be applied to hydrated cells, it permits thicker specimens than EM (up to 10 μm), X-ray absorption spectra of localized regions can be recorded by using different X-ray energies, and potentially three-dimensional imaging could be possible using multiple beams (Yamamoto and Shinohara, 2002).

A major disadvantage is that the X-rays cause tissue damage. When the total X-ray flux goes above 4·10<sup>5</sup> photons per μm<sup>2</sup>, myofibrils lose their contractility; and above 10<sup>6</sup> photons per μm<sup>2</sup>, yeast cells lose their dye exclusion ability (a sign that they are dead or punctured). This is lower than the fluxes of X-ray microscopes with 50 nm resolution, making scanning of tissue while retaining its function impossible (Fujisaki, Takahashi et al., 1996). One way of avoiding degradation of the image is to use a rapid pulse of rays. This also avoids motion blurring due to diffusion in the case of hydrated tissue: to image freely diffusing objects of size 10 nm exposure shorter than 0.1 ms is needed, while a cellular organelle would require between 14 ms – 1.4 s depending on size (Ito and Shinohara, 1992). Using vitrified tissue the radiation dose can be increased thousandfold without structural changes, and the diffusion issue disappears (Methe, Spring et al., 1997). These concerns make X-ray imaging unlikely to work for non-destructive scanning.

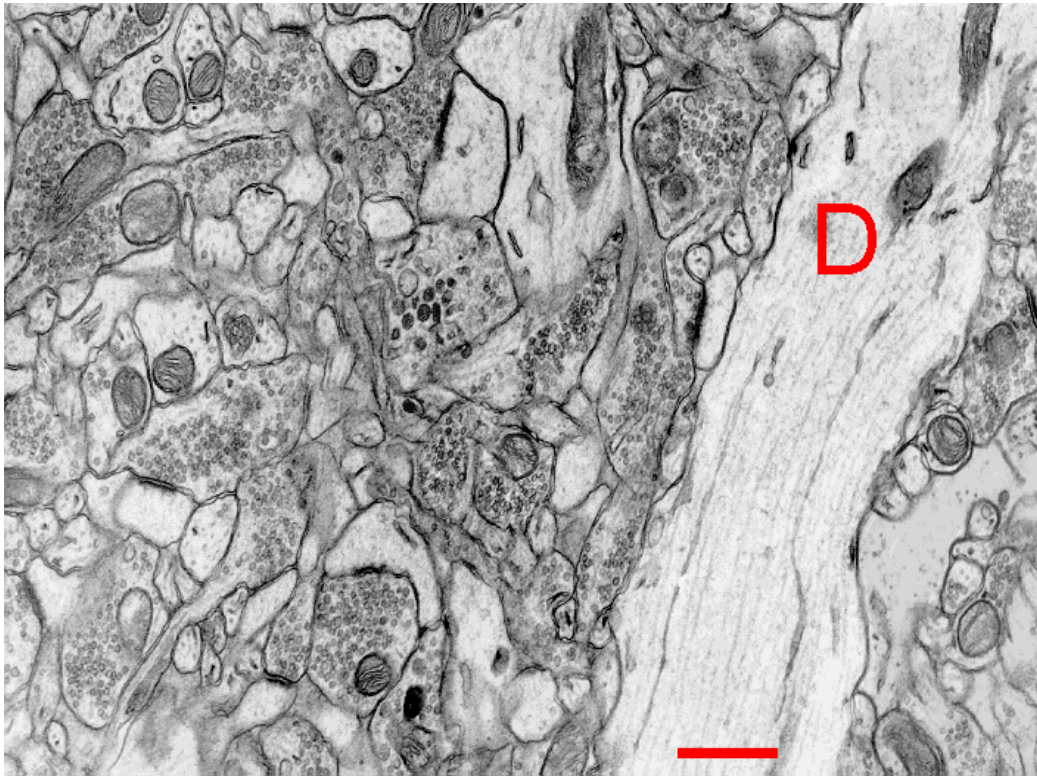
Of particular interest for WBE is the possibility of doing spectromicroscopy to determine the local chemical environment. X-ray absorption edges are affected by the chemical binding state of the atom probed. Different amino acids have distinguishable ‘fingerprints’ that are relatively unaffected by peptide bonding. In principle, the spectra of proteins could be predicted based on their sequences. Scanning X-ray microscopes have long exposure times (minutes), although they deposit 5-10 times less radiation in the sample (Jacobsen, 1999). While currently far too slow for WBE purposes, finding ways of speeding up this process may make it relevant for WBE.

### **Atomic-beam microscopy**

Instead of photons or electrons, neutral atoms could be used to image a sample. Since the de Broglie wavelength of thermal atoms is subnanometer, the resolution could be very high. By using uncharged and inert atoms like helium, the beam would also be non-destructive (Holst and Allison, 1997). Helium atom scattering has a large cross-section with hydrogen, which might make it possible to detect membranes in unstained tissue.

At present, imaging at high resolution using atomic beam microscopy has not been achieved (lower resolution has been achieved (Doak, Grisenti et al., 1999)). Development of ridged atomic mirrors has enabled focusing neutral atom beams (Oberst, Kouznetsov et al., 2005; Shimizu and Fujita, 2002) and would in principle allow focusing the beam to a spot size of tens of nanometers (Kouznetsov, Oberst et al., 2006); by scanning the spot across the sample an image could be built up like in other forms of scanning microscopy.

## Electron microscopy



**Figure 15:** EM picture of rat hippocampus neuropil. D marks a dendrite of a pyramidal cell. Several synapses can be seen to the left, noticeable by the presence of small spherical vesicles on the presynaptic side and a dark postsynaptic density on the receiving side. The scale bar is 1  $\mu\text{m}$ . (Copyright J Spacek, Synapse Web)

Electron microscopy can resolve the fine details of axons and dendrites in dense neural tissue. Images can be created through transmission electron microscopy (TEM), where electrons are sent through tissue, or scanning electron microscopy (SEM) where electrons are scattered from the surface: both methods require fixing the sample by freezing and/or embedding it in polymer. TEM has achieved 0.1 nm imaging (Nellist, Chisholm et al., 2004). However, the main challenge is to automate sectioning and acquisition of data. The three current main methods are serial section electron tomography (SSET), serial section transmission electron microscopy (SSTEM) and serial block-face scanning electron microscopy (SBFSEM) (Briggman and Denk, 2006). Two new methods that may be useful are FEI's DualBeam Focused Ion Beam SEM (FIBSEM) and automatic ultrathin sectioning and SEM imaging (ATLUM).

**SSET:** High resolution TEM 3D images can be created using tilt-series-based tomography where the preparation is tilted relative to the electron beam, enabling the recording of depth information (Frank, 1992; Penczek, Marko et al., 1995). This method appears suited mainly for local scanning (such as imaging cellular organelles) and cannot penetrate very deep into the surface (around 1  $\mu\text{m}$ ) (Lučić, Förster et al., 2005).

**SSTEM:** Creating ultrathin slices for TEM is another possibility. (Tsang, 2005) created a three-dimensional model of the neuromuscular junction through serial TEM of 50 nm sections created using an ultramicrotome. (White, Southgate et al., 1986) used serial sections to

reconstruct the *C. elegans* nervous system. However, sectioning is physically tricky and labor intensive.

**SBFSEM:** One way of reducing the problems of sectioning is to place the microtome inside the microscope chamber (Leighton, 1981); for further contrast, plasma etching was used (Kuzirian and Leighton, 1983). (Denk and Horstmann, 2004) demonstrated that backscattering contrast could be used instead in a SEM, simplifying the technique. They produced stacks of 50-70 nm thick sections using an automated microtome in the microscope chamber, with lateral jitter less than 10 nm. The resolution and field size was limited by the commercially available system. They estimated that tracing of axons with 20 nm resolution and S/N ratio of about 10 within a 200  $\mu\text{m}$  cube could take about a day (while 10 nm x 10 nm x 50 nm voxels at S/N 100 would require a scan time on the order of a year).

Reconstructing volumes from ultrathin sections faces many practical challenges. Current electron microscopes cannot handle sections wider than 1-2 mm. Long series of sections are needed but the risk of errors or damage increase with the length, and the number of specimen holding grids becomes excessive (unless sectioning occurs inside the microscope (Kuzirian and Leighton, 1983)). Current state of the art for practical reconstruction from tissue blocks is about 0.1  $\text{mm}^3$ , containing about  $10^7$ - $10^8$  synapses (Fiala, 2002).

**FIBSEM<sup>5</sup>:** The semiconductor industry has long used focused ion beams (FIB) (usually accelerated beams of gallium ions) to very precisely cutaway parts of integrated circuit chips for failure analysis. Researchers at FEI have recently demonstrated that this technique and instrument can also be applied to plastic embedded neural tissue in a manner similar to the SBFSEM above (Mulders, Knott et al., 2006). In the FIBSEM, the top 30-50 nm layer of a block of tissue (having block face dimensions of approximately 100 x 100  $\mu\text{m}$ ) is ablated away using the focused ion beam. The resulting block face is then imaged with the SEM using the backscatter signal just as is done in the SBFSEM, and this process is repeated to image hundreds of successive layers.

Because the FIBSEM ablates away the block's top layer using an ion beam (instead of a diamond knife), the 'cooking' of the block surface that occurs in SBFSEM due to the high beam current is not a problem. Using longer integration times, FIBSEM images have demonstrated lateral resolutions of 5nm or better and much improved signal to noise ratios.

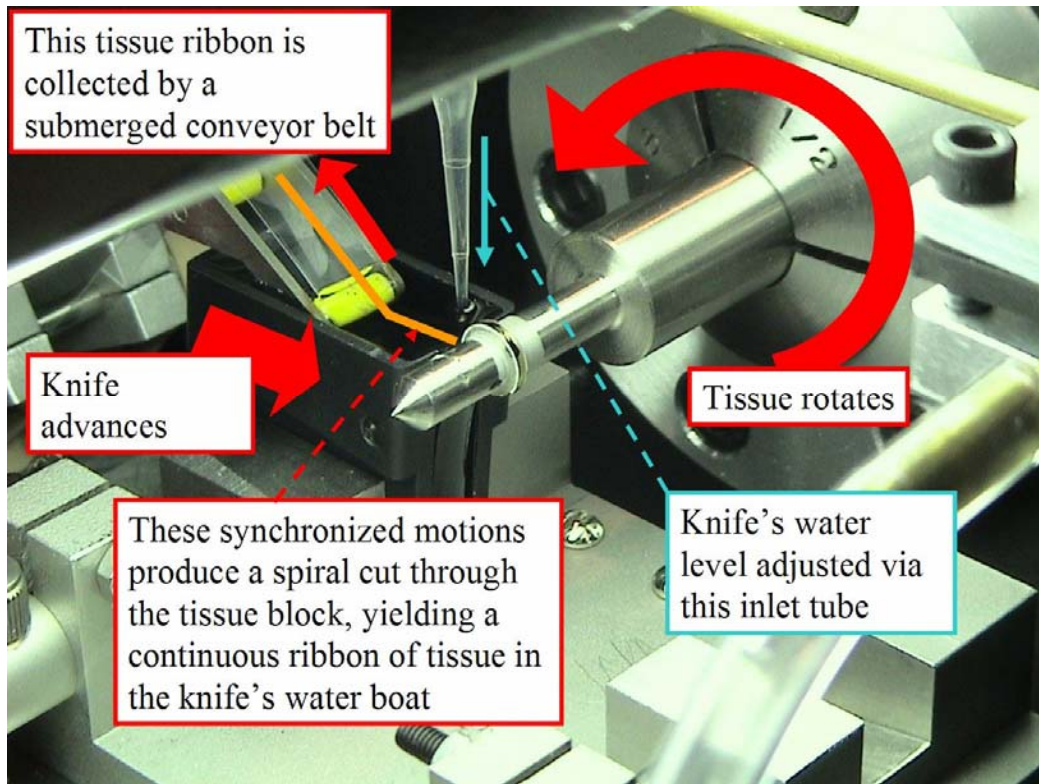
**ATLUM:** The above SSET and SSTEM approaches use sections obtained by diamond knife sectioning on a traditional semi-automated ultramicrotome. This process is only semi-automated because the collection of these sections requires manually scooping free-floating sections from the knife's water boat onto TEM slot grids using an eyelash. This is an inherently unreliable process for all but the smallest volumes.

The Automatic Tape-Collecting Lathe Ultramicrotome (ATLUM) is a prototype machine recently developed at Harvard University that fully automates the process of ultrathin sectioning and collection (Hayworth, Kashturi et al., 2006; Hayworth, 2007). In the ATLUM a tissue sample (typically 1-2mm in width, 10mm long, and 0.5mm deep) is mounted on a steel axle and is rotated continuously via an ultraprecise airbearing while a piezo-driven diamond knife slices off one ultrathin section per revolution. A feedback loop employing capacitive sensors maintains the position of the knife relative to the axle to within approximately 10nm allowing even large area tissue sections (many square millimeters) to be cut to thicknesses

---

<sup>5</sup> Text derived from Kenneth Hayworth.

below 40nm. Each section comes streaming off the knife's edge onto the surface of a water boat attached behind the knife. In traditional ultramicrotomy this fragile floating section would have to be collected manually (via dexterous use of an eyelash) onto a TEM slot grid, a notoriously unreliable process. In contrast, in the ATLUM each section is immediately collected by the mechanism onto a submerged conveyor belt of carbon coated Mylar tape (100  $\mu\text{m}$  thick and 8 mm wide). In this way, hundreds of large-area ultrathin sections are automatically secured onto a meters-long Mylar tape.



**Figure 16: Overview of ATLUM operation. (Copyright Lichtman Lab, Harvard University)**

This tape is subsequently stained with heavy metals and imaged in a SEM. Imaging via the SEM backscatter signal (like the SBFSEM and FIBSEM approaches above) allows the ATLUM to dispense with fragile TEM slot grids (which also removes their width-of-section limitation). The Mylar tape provides a sturdy substrate for handling and storage while its carbon coating prevents charging and beam damage during SEM imaging.

Images obtained from ATLUM tissue tapes are of equivalent quality to traditional TEM images showing lateral resolution better than 5 nanometers. Recent tests have also shown that a tomographic tilt series (as in the SSET technique) may be performed on ATLUM collected sections to obtain additional depth information. This is performed by tilting the section at various angles with respect to the SEM's electron beam thus providing Z-resolutions even finer than the section thickness itself. Because the sections are stored for later imaging they can be post-stained with heavy metals (producing images with superior signal to noise ratios and much faster imaging times than the SBFSEM and FIBSEM block face imagers) and, if needed, they can be poststained with a series of other stains for overlaying chemical analysis maps on the high resolution SEM structural images.

## **Comparison of techniques**

### **Resolution**

With the exception of the SBFSEM, all of these techniques have already demonstrated sufficient resolution to map the exact point-to-point connectivity of brain tissue down to the level of counting synaptic vesicles in individual synapses. With additional modifications it may be possible for the SBFSEM to also reach these resolutions.

### **Reliability and robustness**

Transmission EM techniques like the SSTEM and SSET require sections to be mounted on slot grids. The process of collecting sections on slot grids has not yet been successfully automated, and sections mounted on slot grids are themselves extremely fragile (because they are essentially freely supported structures less than a micron thick). This raises serious doubts as to the feasibility of scaling these techniques up to very large volumes of neural tissue (although machines like the ATLUM may be modifiable to allow automated collection of sections on tapes with prefabricated slots, or alternatively slots can be created in the tape after collection is completed). SEM backscatter imaging seems to offer equivalent resolution and image quality while avoiding these pitfalls intrinsic to TEM approaches.

One remaining possible advantage of TEM approaches is imaging speed. Images in current SEMs are built up one pixel at a time as the electron beam scans across the sample's surface. In contrast, the pixels in TEM images are captured in parallel by a CCD + scintillator mounted below the section. This fact could, in principle, allow imaging times orders of magnitude faster than SEM imaging. However, many technical issues complicate this comparison. In practice, current TEMs image sections only slightly faster than SEMs do. In addition, multibeam SEMs (described below) are currently being developed that will massively parallelize, and thus speed up, SEM image acquisition

Block face approaches (SBFSEM and FIBSEM) have inherent reliability since they avoid the perilous step of collecting ultrathin sections by simply destroying them in situ after having already imaged them. The FIBSEM technique is additionally, at least in principle, robust to small differences in embedding quality. All of the other techniques use diamond knife sectioning which requires good uniformity of resin infiltration and resin hardness throughout the tissue block to section smoothly. Of course tissue samples for all the techniques must be infiltrated correctly for proper ultrastructural preservation

While the ATLUM is necessarily less reliable than block face approaches (since it collects ultrathin sections for later imaging) it still has the potential for extreme reliability over large volumes. This is because the ultrathin sections, within the ATLUM mechanism, are secured to the sturdy Mylar tape almost immediately after they are sectioned by the diamond knife. In fact, the leading edge of each section is secured to the collection tape while the trail edge is still being sectioned by the knife. In this way each section is always under complete control of the mechanism.

### **Imaging time**

For concreteness, let's outline a reasonable near-term neuronal circuit mapping goal necessary to support a set of "partial" brain circuit emulation experiments. We can then compare the imaging times, and thus the feasibility, of the different methods. One of the most interesting and best studied pieces of brain circuitry is that underlying orientation tuning in the primary visual cortex (V1) in the cat and in the primate. This circuit's crude functional properties (orientation tuned 'simple' and 'complex' cells) have been known for decades yet the circuitry underlying these functional responses remains a topic of heated debate



generating dozens of journal articles every year. More importantly, our lack of a detailed understanding of the neuronal circuitry has blocked progress into V1's more subtle computational properties such as its role in perceptual grouping.

A trial brain emulation experiment might set as a goal the modelling of orientation tuning responses of a few cells in V1 (possibly correlated with previous two-photon recording of activity within the same tissue). This task would not require entire volumes of complex neuropil be traced in total. It would require, however, imaging the connectivity of at least several dozen neurons in the various layers of V1, and their connectivity both with each other and with many dozen axonal projections to V1 from the lateral geniculate nucleus (LGN). In addition, these axonal projections from the LGN would need to be traced back to their origins to determine their relative positions and thus to infer their own receptive field properties. In whole, such a study would require nanoresolution tracing of parts of over one hundred neurons and thousands of synaptic connections spanning a volume on the order of  $10\text{mm}^3$  (This is assuming that the myelinated projections between LGN and V1 can be traced at much lower resolution, excluding it from the volume estimate). Because of the nature of the study, such neurons could not be selectively labelled beforehand and so the electron microscopic methods described in this section (which can image any arbitrary neuronal cell or process) are the only current techniques which may be capable of performing the task.

SSET and SSTEM: As discussed above, the manual collection of TEM-ready sections (for techniques like the SSET and SSTEM) is out of the question for volumes as large as  $10\text{mm}^3$ .

SBFSEM and FIBSEM: So far the largest volumes sectioned in these devices have been less than  $0.01\text{mm}^3$ , with blockface dimensions typically  $200 \times 200\ \mu\text{m}$  or less. Imaging rate on these devices is around  $100\text{kHz}$  (10 microseconds per pixel). In general, blockface imaging approaches necessitate such slow imaging rates (to obtain adequate signal to noise ratios) since the material can only be lightly stained while in block form.

Our V1 circuit tracing scenario does not strictly require the entire  $10\text{mm}^3$  volume be imaged at highest resolution; however, as the neuronal circuits to be traced wander randomly throughout the entire volume, one does not know a priori which parts to image at high resolution. Because, in these blockface imaging devices, each section is destroyed in situ, there is only one chance to image it and thus in effect all parts of the volume must be imaged at sufficient resolution to trace the finest neuronal processes. Assuming  $5\text{nm}$  lateral resolution and  $50\text{nm}$  sections (typical values for neuropil tracing studies) the  $10\text{mm}^3$  block consists of  $8 \cdot 10^{15}$  voxels and would require on the order of 2,000 years to image! Such long imaging time makes this tracing study infeasible on these machines.

ATLUM: The largest volume sectioned on the ATLUM so far is  $0.1\text{mm}^3$  with blockface dimensions of  $1.4\text{mm} \times 4.5\text{mm}$  and section thickness of  $45\text{nm}$  (total of 400 sections). ATLUM cutting speed is around  $0.03\text{mm}/\text{sec}$  and each of these ultrathin sections ( $6.3\text{mm}^2$  in area) was produced at a rate of approximately 4 minutes per section. If such a rate could be reliably sustained it would take about 3 months for an ATLUM-like device to reduce a  $10\text{mm}^3$  tissue block to a series of  $50\text{nm}$  sections each securely mounted on a long Mylar tape ready for imaging.

Because the ATLUM collects sections for later imaging, its sections can be poststained with heavy metals. This allows adequate signal to noise ratios with shorter image acquisition times. Imaging rate is around  $1\text{MHz}$  ( $1.0\text{microsecond}$  per pixel) so bulk imaging the entire  $10\text{mm}^3$  would require on the order of 200 years. This still would render the project infeasible;

however, unlike the block face techniques, the ATLUM technique can take advantage of directed high-resolution imaging to dramatically shorten this imaging time.

As stated above, at current sectioning speeds, the ATLUM could reduce a 10mm<sup>3</sup> block of brain tissue to a tape of ultrathin sections in just a few months. Such a tape would constitute a permanent “ultrathin section library” of the entire volume, and any part of it could be randomly imaged (and re-imaged) at whatever resolution desired. A researcher could coarsely image the entire volume in a few days, find a target neuron within the volume, and then subsequently direct high-resolution imaging exactly where it is needed to trace that neuron’s processes and its connections with additional neurons. In this way, a multi-neuron circuit, stretching throughout the entire 10mm<sup>3</sup> volume, could be mapped with synaptic precision while only imaging perhaps one one-thousandth of the whole volume. In this fashion, the ATLUM can potentially reduce the time needed to trace a complete neural circuit from hundreds of years to just a few months, making the V1 trial emulation experiment potentially feasible in the near-term.

Parenthetically, we can also note that the near-term goal of tracing and emulating circuits of a few hundred neurons drastically reduces the image processing and computer simulation requirements. Instead of requiring millions of neurons with billions of synapses to be traced and identified, only the limited subset under study need be traced in the image data. The successful completion of “partial brain” emulation studies (such as the hypothetical V1 study above) is probably a necessary precursor to spur the type of research and investment in sectioning, imaging, tracing, and emulations technologies needed for eventually scaling-up to whole brain emulation levels.

#### **Possibilities for increasing SEM imaging speed**

From the above discussion it is clear that long imaging times constitute a major barrier to whole brain emulation using SEM techniques. However, there is currently a major research push toward massively parallel multi-beam SEMs which has the potential to speed up SEM imaging by many orders-of-magnitude. This research push is being driven by the semiconductor industry as part of its effort to reduce feature sizes on computer chips below the level that traditional photolithography can produce.

The circuitry patterns within computer chips are produced through a series of etching and doping steps. Each of these steps must affect only selected parts of the chip, so areas to be left unaffected are temporally covered by a thin layer of polymer which is patterned in exquisite detail to match the sub-micron features of the desired circuitry. For current mass production of chips this polymer layer is patterned by shining ultraviolet light through a mask onto the surface of the silicon wafer which has been covered with the photopolymer in liquid form. This selectively cures only the desired parts of the photopolymer. To obtain smaller features than UV light can allow, electron beams (just as in a SEM) must instead be used to selectively cure the photopolymer. This process is called e-beam lithography. Because the electron beam must be rastered across the wafer surface (instead of flood illuminating it as in light lithography) the process is currently much too slow for production level runs.

Several research groups and companies are currently addressing this speed problem by developing multi-beam e-beam lithography systems (Kruit, 1998; van Bruggen, van Someren et al., 2005; van Someren, van Bruggen et al., 2006; Arradiance Inc). In these systems, hundreds to thousands of electron beams raster across a wafer’s surface simultaneously writing the circuitry patterns. These multi-beam systems are essentially SEMs, and it should be a straightforward task to modify them to allow massively parallel scanning as well

(Pickard, Groves et al., 2003). For backscatter imaging (as in the SBFSEM, FIBSEM, and ATLUM technologies) this might involve mounting a scintillator with a grid of holes (one for each e-beam) very close to the surface of the tissue being imaged. In this way the interactions of each e-beam with the tissue can be read off independently and simultaneously.

It is difficult to predict how fast these SEMs may eventually get. A 1,000 beam SEM where each individual beam maintains the current 1 MHz acquisition rate for stained sections appears reachable within the next ten years. We can very tentatively apply this projected SEM speedup to ask how long imaging a human brain would take. First, assume a brain were sliced into 50nm sections on ATLUM-like devices (an enormous feat which would itself take approximately 1,000 machines – each operating at 10x the current sectioning rate – a total of 3.5 years to accomplish). This massive ultrathin section library would contain the equivalent of  $1.1 \cdot 10^{21}$  voxels (at  $5 \times 5 \times 50$  nm per voxel). Assuming judicious use of directed imaging within this ultrathin section library only 1/10 may have to be imaged at this extremely high resolution (using much lower, and thus faster, imaging on white matter tracts, cell body interiors etc.). This leaves roughly  $1.1 \cdot 10^{20}$  voxels to be imaged at high resolution. If 1,000 SEMs each utilizing 1,000 beamlets were to tackle this imaging job in parallel their combined data acquisition rate would be  $1 \cdot 10^{12}$  voxels per second. At this rate the entire imaging task could be completed in less than 4 years.

## Nanodisassembly

The most complete approach would be to pick the brain apart atom by atom or molecule by molecule, recording their position and type for further analysis. The scenario in (Morevec, 1988) can also be described as nanodisassembly (in an unfixated brain, with on-the-fly emulation) working on a slightly larger size scale. (Merkle, 1994) describes a relatively detailed proposal where the brain is divided into  $3.2 \cdot 10^{15}$   $0.4 \mu\text{m}$  cubes where each cube would be disassembled atomically (and atom/molecule positions recorded) by a disassembler nanodevice (Drexler, 1986) over a three year period.

It has been pointed out that medical nanorobotics is the form of nanotechnology best used for non-destructive scanning<sup>6</sup>. Given that no detailed proposal for a nanodisassembler has been made it is hard to evaluate the chances of nanodisassembly. It would have to act at a low temperature to prevent molecules in the sample from moving around, removing surface molecules one by one, identifying them and transmitting the position, orientation and type to second-line data aggregators. Clear challenges are the construction of tool tips that can extract arbitrary molecules or detect molecular type for further handling with specialized tool tips, as well as handling macromolecules and fragile molecular structures. Macromolecules can likely not be pulled out in one piece. Atomic disassembly would avoid the complications of molecules for the greater simplicity of a handful of atom types, at the price of needing to break molecular bonds, the risk of ensuing rearrangements and the possibility of creating reactive free radicals. Mature productive nanosystems would appear to be a necessary precursor technology for this approach (probably for the production of the massively parallel disassembly system required for controlled atomic disassembly of a macroscopic object) (Foresight Nanotech Institute and Batelle Memorial Institute, 2007). It appears likely that the kind of technology needed for disassembly would be significantly more complex than the one needed for atomically precise assembly.

---

<sup>6</sup> Robert Freitas Jr., personal communication.

## Chemical analysis

A key challenge is to detect the chemical state and type of cellular components. Normally this is done by staining with dyes or quantum dots that bind to the right target, followed by readout using optical methods. Beside the need for diffusing dyes through the samples, each dye is only selective for a certain target or group of targets, necessitating multiple dyes for identifying all relevant components. If the number of chemicals that have to be identified is large, this would make dyeing ineffective.

One possible approach is Raman microspectroscopy (Krafft, 2004; Krafft, Knetschke et al., 2003), where near-infrared scattering is used to image the vibration spectrum of the chemical components (mainly macromolecules) of tissue. The resolution for near infrared spectroscopy is about 1  $\mu\text{m}$  (limited by diffraction) and confocal methods can be used for 3D imaging. Recording times are very long, on the order of minutes for individual pixels; in order to be useful for WBE this has to be speeded up significantly or parallelized. Using shorter wavelengths appears to induce tissue damage (Puppels, Olminkhof et al., 1991), which may be of little concern for destructive scanning. Ultraviolet resonance microspectroscopy has also been used, enabling selective probing of certain macromolecules (Pajcini, Munro et al., 1997; Hanlon, Manoharan et al., 2000). In some cases native fluorescence can enable imaging by triggering it with UV light, laser-induced native fluorescence, LINF, such as in the case of serotonin (Tan, Parpura et al., 1995; Parpura, Tong et al., 1998) and possibly dopamine (Mabuchi, Shimada et al., 2001).

A new method with great promise is array tomography, a hybrid between optical fluorescence imaging and electron microscopy (Micheva and Smith, 2007). Samples are cut into ultrathin (50-200 nm thick) sections forming an ordered array on a glass slide. The array is then labelled with fluorescent antibodies or other stains and imaged, generating a 3D reconstruction with a depth resolution set by the sectioning thickness. After this imaging the array can be eluted to remove the stain, restained with a new stain, imaged and so on. Finally it can be stained with metal and imaged in a scanning electron microscope. The different image stacks can then be combined, giving a high resolution 3D reconstruction with chemical information.

At present it looks uncertain how much functionally relevant information can be determined from spectra. If the number of neuron types is relatively low and chemically distinct, it might be enough to recognize their individual profiles. Adding dyes tailored to disambiguate otherwise indistinguishable cases may also help.

## Embedding, fixation and staining techniques

Most forms of destructive scanning require fixation and embedding the brain to be scanned so that it can be handled, sectioned, and imaged well. This process must preserve ultrastructure and necessary chemical information.

Current electron microscopy often relies on osmium tetroxide and other heavy metal stains to stain cell membranes for improved contrast (Palay, McGee-Russell et al., 1962). It appears likely that unless pure morphology can be used to deduce functional properties, improved staining methods are needed to create a link between what can be imaged and what is functionally relevant. This might be an area where nanoparticles (and later, more advanced nanodevices) will be important.

## Conclusion

It is likely that the scanning methods used to provide raw data for WBE will be, at least in the early days, destructive methods making use of sectioning and scanning.

Assuming that imaging the finest axonal processes and synaptic spines are required ( $\approx 50\text{nm}$ ), this sets a resolution requirement on the order of 5 nm at least in two directions. Comparing the methods mentioned and their resolution we get the following categorization:

**Table 5: Scanning methods**

Method	Resolution	
MRI	$> 5.5 \mu\text{m}$ (non-frozen)	Does not require sectioning, may achieve better resolution on vitrified brains.
MRI microscopy	$3 \mu\text{m}$	
NIR microspectroscopy	$1 \mu\text{m}$	
All-optical histology	$0.7 \mu\text{m}$	
KESM	$0.3 \mu\text{m} \times 0.5 \mu\text{m}$	
X-ray microtomography	$0.47 \mu\text{m}$	
MRFM	$80 \text{nm}$	
SI	$50 \text{nm}$	
X-ray microscopy	$30 \text{nm}$	Spectromicroscopy possible?
Required resolution?		
SBFSEM	$50\text{-}70 \text{nm} \times 1\text{-}20 \text{nm}$	
FIBSEM	$30\text{-}50 \text{nm} \times 1\text{-}20 \text{nm}$	
ATLUM	$40 \text{nm} \times 5 \text{nm}$	
SSET	$50 \text{nm} \times 1 \text{nm}$	
Atomic beam microscopy	$10 \text{nm}$	Not implemented yet.
NSOM	$5 \text{nm}?$	Requires fluorescent markers, spectroscopy possible.
SEM	$1\text{-}20 \text{nm}$	
Array tomography	$1\text{-}20 \text{nm}$ SEM, $50 \times 200 \times 200 \text{nm}$ fluorescence stains	Enables multiple staining
TEM	$<1 \text{nm}$	Basic 2D method, must be combined with sectioning or tomography for 3D imaging. Damage from high energy electrons at high resolutions.

A  $5 \times 5 \times 50 \text{nm}$  resolution brain scan requires  $1.4 \cdot 10^{21}$  voxels, a large amount of raw data (see next section). Destructive scanning working on fixated brains may avoid having to store the entire dataset by only storing the most recent slices of brain and perform image processing on these. Instead of first scanning the entire brain, and then processing the image data to extract the relevant features and neuronal network, the extraction can proceed piecemeal and concurrently as new imaging data is collected. Once relevant information has been extracted from a data batch, the raw visual data for that batch can be discarded.

However, ideas such as the single brain physical library (Hayworth, 2002) demonstrate that the scanning does not have to be single-shot: a brain is sectioned and fixed in a suitable manner for interactive scanning (possibly using several modalities) and retrieval. This also gets around the data storage problem by only needing to scan regions of interest and store their data (possibly temporarily, since they can be re-scanned if needed later). In early neuroinformatics applications, this might include mapping out the long-range connectivity of a subset of representative neurons in order to find their morphology and connectivity, only requiring imaging a very small subset of the brain's volume (0.01% for mapping out 100,000 neurons in a human brain). It may also be possible to combine this approach with methods like array tomography (Micheva and Smith, 2007) for combined chemical and structural maps.

Low resolution methods such as optical microscopy are an important test of many aspects of the WBE research endeavour, such as large-scale data management, inferring neural function from morphology (possibly using spectroscopy or other methods of estimating chemical states), and providing early test data for tracing and connectivity reconstruction algorithms.

If the required level of simulation is at level 5 or above (detailed cellular electrophysiology and neuron connectivity: see Table 2) we appear to have already achieved the resolution requirements and the remaining problem is in data/tissue management and scaling up methods to handle large brains. Using KESM or ATLUM it should be possible in the very near future to construct a detailed connectome of the brain, in particular the exact interconnections of cortical minicolumns.

If the required level for WBE is below level 5, increases of imaging resolution are of relatively limited use. Rather, we need modalities that enable mapping the proteins, possibly their states and the presence of metabolites or RNA transcripts. This would pose a major research challenge, although it is in line with much research interest today examining the biophysics of cells.

## *Image processing and scan interpretation*

The data from the scanning must be postprocessed and interpreted in order to become useful for brain emulation (or other research). Cell membranes must be traced, synapses identified, neuron volumes segmented, distribution of synapses, organelles, cell types and other anatomical details (blood vessels, glia) identified. Currently this is largely done manually: cellular membranes can be identified and hand-traced at a rate of 1-2 hours/ $\mu\text{m}^3$  (Fiala and Harris, 2001), far too slow for even small cortical volumes.

Software needed includes (after (Fiala, 2002)):

- Geometric adjustment (aligning sections, handling shrinkage, distortions)
- Noise removal
- Data interpolation (replacing lost or corrupted scan data)
- Cell membrane tracing (segmentation, tracing in 2D and 3D)
- Synapse identification
- Identification of cell types
- Estimation of parameters for emulation
- Connectivity identification
- Databasing

Data handling is at present a bottleneck.  $0.1 \text{ mm}^3$  at  $400 \text{ pixels}/\mu\text{m}$  resolution and  $50 \text{ nm}$  section thickness would (compressed) contain 73 terabytes of raw data. A full brain at this resolution would require  $10^9$  terabytes (Fiala, 2002). While extremely large, even this might one day be regarded as feasible (see Appendix B). However, as mentioned in the previous chapter, for emulation purposes it may be far more practical to perform a sequence of scanning and interpretation steps so that only a smaller buffer of high resolution data is necessary.

If the brain is divided into small blocks, each block could be analyzed independently, at least in terms of low-level image processing and preliminary tracing. Data from neighbouring blocks would need to be compared but there is no need for the analysis of more remote blocks (with the possible exception of interpolating lost data). This suggests that it can be parallelized to a great degree. As the scan progresses, low-level data can be discarded to make room for the compressed high-level representation needed to build the emulation<sup>7</sup>.

This section deals with the assumption that WBE is achieved using image-based methods rather than correlation analysis methods where e.g. nanomachines record local neural activity and estimate connectivity from the correlations in the activity pattern. Correlation methods would have corresponding demands for signal processing and inference, but in the time domain rather than the space domain.

### **Geometric adjustment**

Various methods for achieving automatic registration (correcting differences in alignment) of image stacks are being developed. At its simplest, registration involves finding a combination of translation, scaling, and rotation that makes subsequent images match best. However, skewing and non-linear distortions can occur, requiring more complex methods. Combining this with optimization methods and an elastic model to correct for shape distortion produced

---

<sup>7</sup> This loss of data may be of concern since initial scans are likely to be expensive (and hence hard to repeat), and for human brains (which are individually valuable). Some forms of scanning such as ATLUM may produce storable 'libraries' of slices that can be retained for re-scanning or further analysis (Hayworth, 2002).

good results with macroscopic stacks of rat and human brains (Schmitt, Modersitzki et al., 2007).

## **Noise removal**

Removing noise from images is part of standard image processing, with an extensive literature and strong research interest. In general, noise removal is simplified when the kinds of noise introduced by scanning artefacts and the nature of the system are known. As an example, see (Mayerich, McCormick et al., 2007) where light variations and knife chatter noise were removed from KESM data.

## **Data interpolation**

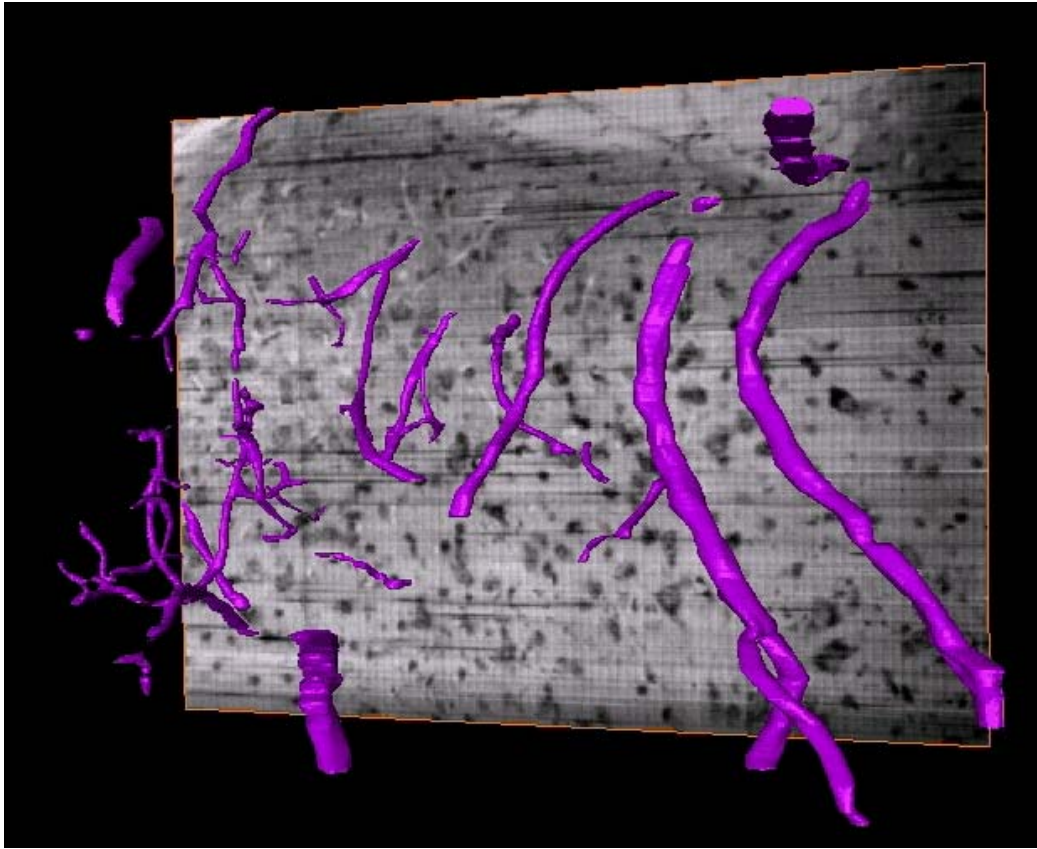
Lost/corrupted data must be replaced with probabilistic interpolations. This might require feedback from later stages to find the most likely interpretation or guess, constrained by what makes sense given known data.

For large lost volumes, generic neurons and connectivity might have to be generated based on models of morphology and connectivity. The goal would be to avoid changing the functionality of the total network. Early results in WBE and statistics from successful imaging volumes should provide much useful input in developing this.

Sectioning the brain into individually scannable chunks will introduce data loss and possible misalignment along the edges (for example, the KESM suffers damage up to 5  $\mu\text{m}$  in width between different columns (Kwon, Mayerich et al., 2008)). This may prove to be the major source of lost data in WBE. Since this could cause mis-tracing of long axons crossing numerous chunk boundaries, solving this issue is a high priority. Alignment can probably be achieved reliably if the lost zone is sufficiently smaller than the correlation length in the surrounding images.



## Cell tracing



**Figure 17: Blood vessel reconstruction from KESM Nissl data. (Copyright brain Networks Laboratory, Texas A&M University)**

Automated tracing of neurons imaged using confocal microscopy has been attempted using a variety of methods. Even if the scanning method used will be a different approach it seems likely that knowledge gained from these reconstruction methods will be useful.

One approach is to enhance edges and find the optimal joining of edge pixels/voxels to detect contours of objects. Another is skeletonization. For example, (Urban, O'Malley et al., 2006) thresholded neuron images (after image processing to remove noise and artefacts), extracting the medial axis tree. (Dima, Scholz et al., 2002) employed a 3D wavelet transform to perform a multiscale validation of dendrite boundaries, in turn producing an estimate of a skeleton.

A third approach is exploratory algorithms, where the algorithm starts at a point and uses image coherency to trace the cell from there. This avoids having to process all voxels, but risks losing parts of the neuron if the images are degraded or unclear. (Al-Kofahi, Lasek et al., 2002) use directional kernels acting on the intensity data to follow cylindrical objects. (Mayerich and Keyser, 2008) use a similar method for KESM data, accelerating the kernel calculation by using graphics hardware. (Uehara, Colbert et al., 2004) calculates the probability of each voxel belonging to a cylindrical structure, and then propagates dendrite paths through it.

One weakness of these methods is that they assume cylindrical shapes of dendrites and the lack of adjoining structures (such as dendritic spines). By using support-vector machines that are trained on real data a more robust reconstruction can be achieved (Santamaría-Pang, Bildea et al., 2006).

Overall, tracing of branching tubular structures is a major interest in medical computing. A

survey of vessel extraction techniques listed 14 major approaches, with several examples of each (Kirbas and Quek, 2004). The success of different methods is modality-dependent.

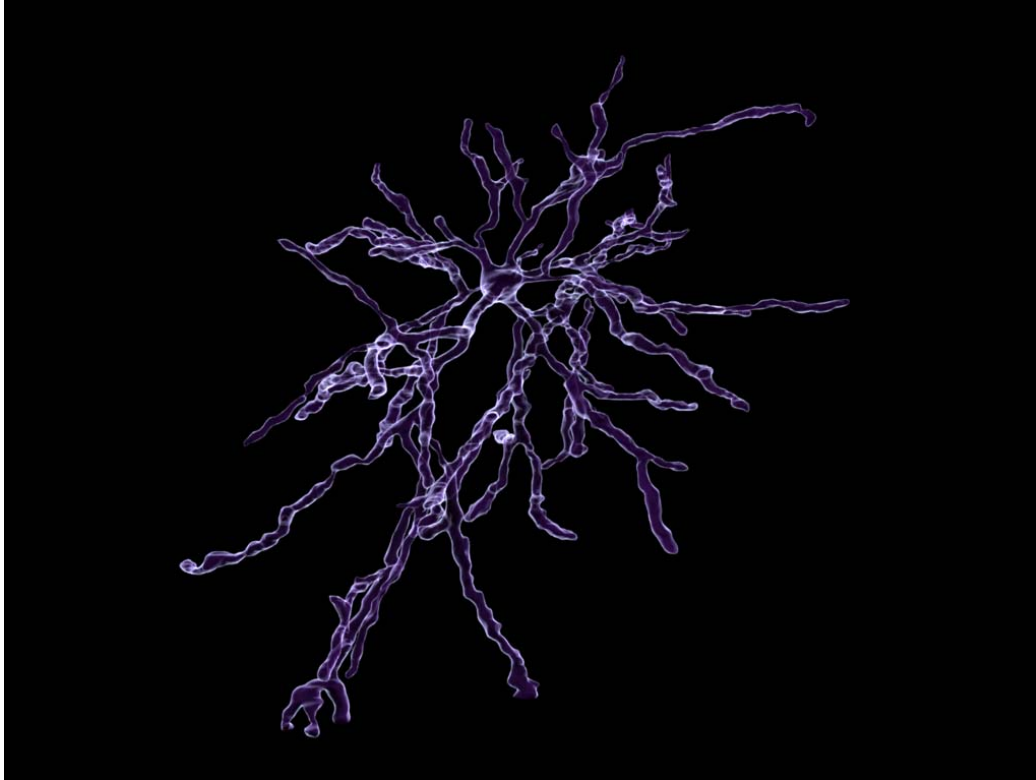


Figure 18: 3D visualization of Golgi-stained cell reconstructed from KESM data.  
(Copyright Brain Networks Laboratory, Texas A&M University)

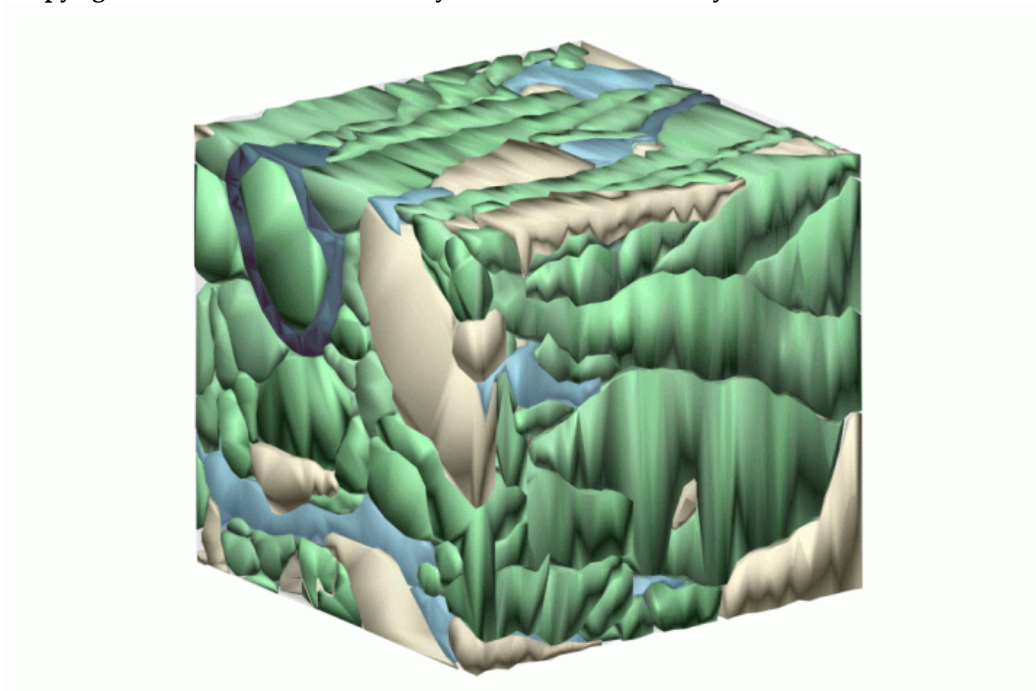
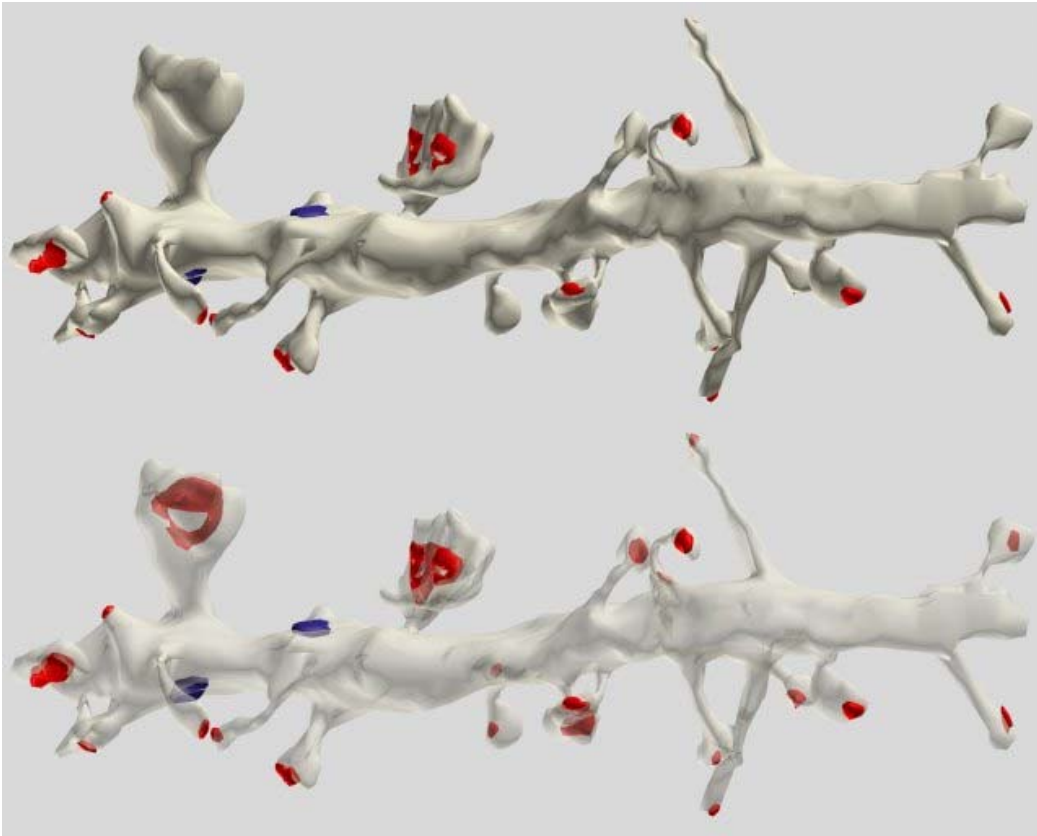


Figure 19: 3D reconstruction of a cube (2 μm side) of neuropil from rat hippocampus.  
Axons are green, dendrites ochre, astrocytes pale blue, myelin dark blue. (Copyright J Spacek, Synapse Web)

## Synapse identification



**Figure 20: Reconstructed spiny dendrite of CA1 pyramidal cell, rendered from data in (Harris and Stevens, 1989). (Copyright Synapse Web)**

In electron micrographs, synapses are currently recognized using the criteria that within a structure there are synaptic vesicles adjacent to a presynaptic density, a synaptic density with electron-dense material in the cleft and densities on the cytoplasmic faces in the pre- and postsynaptic membranes (Colonnier, 1981; Peters and Palay, 1996).

One of the major unresolved issues for WBE is whether it is possible to identify the functional characteristics of synapses, in particular synaptic strength and neurotransmitter content, from their morphology.

In general, cortical synapses tend to be either asymmetrical “type I” synapses (75-95%) or symmetrical “type II” synapses (5-25%), based on having a prominent or thin postsynaptic density. Type II synapses appear to be inhibitory, while type I synapses are mainly excitatory (but there are exceptions) (Peters and Palay, 1996). This allows at least some inference of function from morphology.

The shape and type of vesicles may also provide clues about function. Small, clear vesicles appear to mainly contain small-molecule neurotransmitters; large vesicles (60 nm diameter) with dense cores appear to contain noradrenaline, dopamine or 5-HT; and large vesicles (up to 100 nm) with 50-70 nm dense cores contain neuropeptides (Hokfelt, Broberger et al., 2000; Salio, Lossi et al., 2006). Unfortunately there does not appear to be any further distinctiveness of vesicle morphology to signal neurotransmitter type.

## Identification of cell types

Distinguishing neurons from glia and identifying their functional type requires other advances in image recognition.

The definition of neuron types is debated, as well as the number of types. There might be as many as 10,000 types, generated through an interplay of genetic, posttranscriptional, epigenetic, and environmental interactions (Muotri and Gage, 2006). There are some 30+ named neuron types, mostly categorized based on chemistry and morphology (e.g. shape, the presence of synaptic spines, whether they target somata or distal dendrites). Distinguishing morphologically different groups appear feasible using geometrical analysis (Jelinek and Fernandez, 1998).

In terms of electrophysiology, excitatory neurons are typically classified into regular-spiking, intrinsic bursting, and chattering, while interneurons are classified into fast-spiking, burst spiking, late-spiking and regular spiking. However, alternate classifications exist. (Gupta, Wang et al., 2000) examined neocortical inhibitory neurons and found three different kinds of GABAergic synapses, three main electrophysiological classes divided into eight subclasses, and five anatomical classes, producing 15+ observed combinations. Examining the subgroup of somatostatin-expressing inhibitory neurons produced three distinct groups in terms of layer location and electrophysiology (Ma, Hu et al., 2006) with apparently different functions. In prefrontal cortex layer 2/3 inhibitory neurons' morphology and electrophysiology also produced clusters of distinct types (Krimer, Zaitsev et al., 2005).

Overall, it appears that there exist distinct classes of neurons in terms of neurotransmitter, neuropeptide expression, protein expression (e.g. calcium binding proteins), and overall electrophysiological behaviour. Morphology often shows clustering, but there may exist intermediate forms. Similarly, details of electrophysiology may show overlap between classes, but have different population means.

Some functional neuron types are readily distinguished from morphology (such as the five types of the cerebellar cortex). A key problem is that while differing morphologies likely implies differing functional properties, the reverse may not be true. Some classes of neurons appear to show a strong link between electrophysiology and morphology (Krimer, Zaitsev et al., 2005) that would enable inference of at least functional type just from geometry. In the case of layer 5 pyramidal cells, some studies have found a link between morphology and firing pattern (Kasper, Larkman et al., 1994; Mason and Larkman, 1990), while others have not (Chang and Luebke, 2007). It is quite possible that different classes are differently identifiable, and that the morphology-function link could vary between species.

In many species there exist identifiable neurons, neurons that can be distinguished from other neurons in the same animal and identified across individuals, and sets of equivalent cells that are mutually indistinguishable (but may have different receptive fields) (Bullock, 2000). While relatively common in small and simple animals, identifiable neurons appear to be a minority in larger brains. Early animal brain emulations may make use of the equivalence by using data from several individuals, but as the brains become larger it is likely that all neurons have to be treated as individual and unique.

## Estimation of parameters for emulation

(Markram, 2006) lists the following necessary building blocks for reconstructing neural microcircuits:

**Table 6: Necessary data for reconstructing neural microcircuits**

Network	Total number of neurons		
Neurons	Gene expression profiles	Morpho-electrophysiological types	Ion channel compositions
	Electrophysiological profiles		Ion channel distributions
	Morphological profiles		Frequencies of occurrence
Structural connectivity	Presynaptic	Total number of boutons	
		Total number of targets	
		Terminals per connection	
		Presynaptic innervation pattern	
	Postsynaptic	Total synapse numbers	
		Synapses per connection	
		Postsynaptic innervation patterns	
Functional connectivity	Synaptic biophysics	Transmission statistics	
		Connection conductances	
		Synapse conductances	
		Neurotransmitter receptors	
		Ionic permeabilities	
	Synaptic dynamics	Reversal potentials	
		Probabilities of release	
		Depression time constants	
		Facilitation time constants	
		Long-term plasticities	

Many of these are in turn multivariate, such as ionic permeabilities or the list of conductances.

Neuron data in the Neocortical Microcircuit Database (Markram, 2005) include 135 electrophysiological parameters derived from responses to stimuli, 234 geometric parameters based on neural reconstruction and 51 genetic properties from single cell RT-PCR data. For synapses data on involved cell identities, anatomical properties (15 parameters), physiological properties (reversal potential and pharmacological block), synaptic dynamics (5 parameters) and kinetics (14 parameters).

## Electrophysiology

Given electrophysiological data of a cell's responses to simple current stimuli it is possible to replicate the response in a compartment model (in particular the density of ionic channels) through automated methods such as genetic algorithms and simulated annealing (Druckmann, Banitt et al., 2007; Keren, Peled et al., 2005; Vanier and Bower, 1999; Van Geit, Achard et al., 2007). However, fitting experiments have shown that the same neural activity can be produced by different sets of conductances (Achard and De Schutter, 2006). This may suggest less need to detect all ionic conductances if done by other means, but the results also suggest that the set of good models form relatively isolated hyperplanes: relatively precise fitting of all parameters is needed to get good performance.

## Gene expression

Different inhibitory interneurons show different gene expression for different receptors, ion channels and gap junction-forming proteins (Blatow, Caputi et al., 2005). Strong correlations between gene expression of certain ion channels and conductances have been observed suggesting that function can be inferred from genetic data (Toledo-Rodriguez, Blumenfeld et al., 2004). Different neurons show variable expression levels, yet different neuron types have unique patterns (Schulz, Goillard et al., 2006; Schulz, Goillard et al., 2007). Differences in alternate splicing have been found in individual cells within a neuron population, but there are also differences in splicing in different brain regions suggesting there are overall regulatory mechanisms (Wang and Grabowski, 1996).

If scanning can detect relevant mRNA levels (and the link between these and functional properties have been found using high-throughput analysis of all kinds of neurons) it would likely be possible to deduce functional type.

## Detecting synaptic efficacies

Normally synaptic properties are determined electrophysiologically by triggering action potentials in the presynaptic neuron and measuring the response in the postsynaptic neuron. This can detect not just the general strength of the synapse but also adaptation properties.

There are cases where electrophysiological properties appear to be linked to detectable differences in synaptic morphology, in particular the appearance of vesicle ribbons (Fields and Ellisman, 1985; Hull, Studholme et al., 2006). LTP likely affects synaptic curvature, size and perforations of the postsynaptic density in a time dependent manner (Marrone and Petit, 2002; Marrone, 2007). It is commonly assumed that this, as well as more short-term electrophysiological changes, involves remodelling of the cytoskeleton in response to plasticity (Dillon and Goda, 2005; Chen, Rex et al., 2007). Particular proteins, such as profilin, a regulator of actin polymerisation, are activated by LTP-inducing stimuli and may indicate synapses that are potentiating (Ackermann and Matus, 2003).

Many synapses are “silent”, lacking membrane AMPA-receptors; stimulation can produce a transition to an active “vocal” state (Kullmann, 2003). Silent synapses do not appear different in micrographs, suggesting a negative answer to the question of whether function can be inferred from EM structure (Atwood and Wojtowicz, 1999). This means that for WBE detecting at least AMPA may be necessary; this could likely be achieved using array tomography.

## Connectivity identification

This step assigns synaptic connections between neurons.

At present, statistical connectivity rules are used based on proximity, the “Peters’ rule”, in which synaptic connections are assumed where axons with boutons overlap with dendrites (Braitenberg and Schuz, 1998; Peters, 1979). This can be used to estimate the statistics of synaptic connectivity (Binzegger, Douglas et al., 2004; Shepherd, Stepanyants et al., 2005; Kalisman, Silberberg et al., 2003). However, neural geometry cannot predict the strength of functional connections reliably, perhaps because synaptic plasticity changes the strength of geometrically given synapses (Shepherd, Stepanyants et al., 2005).

It is not possible to rely on synapses only occurring from axons to dendrites; axo-somatic, axo-axonic, and dendro-dendritic (which may be one-way or reciprocal) synapses have been observed. Occasionally, several synapses coincide, such as serial axoaxodendritic synapses and synaptic glomeruli where an axon synapses onto two dendrites, one of which also synapses on the other.

One possibility is that there exists enough stereotypy (repeating patterns of structural and functional features) in the brain to simplify connectivity identification (and possibly interpolation) (Silberberg, Gupta et al., 2002). Such information would constrain the interpretation process by ruling out certain possibilities, which would at the very least enable a speedup. Acquiring the potentially very complex information about stereotyped arrangements would be one of the earliest applications and benefits of detailed scanning and massive neuroinformatics databases. However, deviations from stereotypy may be of particular importance in achieving person WBE since they can represent individual variations or characteristics.

Gap junctions, where the pre- and postsynaptic cells are electrically linked by connexon channels through the cell membrane, can be identified by membranes remaining parallel with just 2 nm separation and a grid of connexons. They appear to be relatively rare in mammals, but occur at least in the retina, inferior olive and lateral vestibular nucleus (Peters and Palay, 1996).

At least in simple nervous systems such as *C. elegans* gene expression contains significant information about its connectivity signature (Kaufman, Dror et al., 2006). At the very least, the availability of this kind of information could be used to constrain neuron types and connectivity.

## Conclusion

Image processing is a mature area with many commercial and scientific applications. Development of basic processing for handling the scan data does not appear to pose many problems beyond the need for extremely high-throughput signal and image processing, and perhaps the data management issues of the raw scans.

The neuroinformatics/WBE-related further processing steps pose a research challenge. Identifying cellular objects, in particular connectivity and synapses, is a non-trivial image interpretation problem that is currently being studied. Basic contouring algorithms appear to work reasonably well, and it is likely, given other results in current image recognition, that synapse detectors could be constructed. Image interpretation is traditionally a computationally costly operation, and may conceivably be a bottleneck in developing early WBE models (in the long run, assuming improvements in computer hardware necessary anyway for large-scale emulation, this bottleneck is unlikely to remain).

The hardest and currently least understood issue is estimating emulation parameters from imagery (or developing scanning methods that can gain these parameters). This represents one of the key research issues WBE need to answer (if only tentatively) in order to assess its viability as a research program.

## *Neural simulation*

The area of neural simulation began with the classic Hodgkin and Huxley model of the action potential (Hodgkin and Huxley, 1952). At the time, calculating a single action potential using a manually cranked calculator took 8 hours of hard manual labour. Since then the ability to compute neural activity across large networks has grown enormously (Moore and Hines, 1994).

### **How much neuron detail is needed?**

It is known that the morphology of neurons affects their spiking behaviour (Ascoli, 1999), which suggests that neurons cannot simply be simulated as featureless cell bodies. In some cases simplifications of morphology can be done based on electrical properties (Rall, 1962), but it is unlikely this is generic.

An issue that has been debated extensively is the nature of neural coding and especially whether neurons mainly make use of a rate code (where firing frequency contains the signal) or the exact timing of spikes matter (Rieke, Warland et al., 1996). While rate codes transmitting information have been observed, there also exist fast cognitive processes (such as visual recognition) that occur on timescales shorter than the necessary temporal averaging for rate codes. Neural recordings have demonstrated both precise temporal correlations between neurons (Lestienne, 1996) and stimulus-dependent synchronization (Gray, Konig et al., 1989). At present, the evidence that spike timing is essential is incomplete, but there does not appear to be any shortage of known neurophysiological phenomena that could be sensitive to it. In particular, spike timing dependent plasticity (STDP) allows synaptic connections to be strengthened or weakened depending on the exact order of spikes with a precision  $< 5$  ms (Markram, Lubke et al., 1997; Bi and Poo, 1998). Hence it is probably conservative to assume that brain emulation needs a time resolution smaller than 0.4–1.4 ms (Lestienne, 1996) in order fully to capture spike timing.

The time resolution is constrained by the above spike timing requirement as well as numeric considerations in modelling action potentials (where the dynamics become very stiff). Ion channels open in 0.1 ms, suggesting that emulations that do not depend on individual detailed ion channel dynamics might need this time resolution. If they also take individual ion channels and enzymes into account, they would have to be 1-3 orders of magnitude more detailed.

One of the most important realizations of computational neuroscience in recent years is that neurons in themselves hold significant computational resources. “Dendritic computing” involves nonlinear interactions in the dendritic tree, allowing parts of neurons to act as artificial neural networks on their own (Single and Borst, 1998; London and Hausser, 2005; Sidiropoulou, Pissadaki et al., 2006). It appears possible that dendritic computation is a significant function that cannot be reduced into a point cell model but requires calculation of at least some neuron subsystems.

### **Internal Chemistry**

Brain emulation needs to take chemistry more into account than commonly occurs in current computational models (Thagard, 2002). Chemical processes inside neurons have



computational power on their own and occur on a vast range of timescales (from sub-millisecond to weeks). Neuromodulators and hormones can change the causal structure of neural networks, e.g. by shifting firing patterns between different attractor states.

About 200 chemical species have been identified as involved in synaptic plasticity, forming a complex chemical network. However, much of the complexity may be redundant parallel implementations of a few core functions such as induction, pattern selectivity, expression of change, and maintenance of change (where the redundancy improves robustness and offers the possibility of fine-tuning) (Ajay and Bhalla, 2006).

At the very low numbers of molecules found in synaptic spines, chemical noise becomes a significant factor, making chemical networks that are bistable at larger volumes unstable below the femtoliter level and reducing pattern selection (Bhalla, 2004b, a). It is likely that complex formation or activity constrained by membranes is essential for the reliability of synapses. However, this may not necessarily require detailed modelling of the complexes themselves, just of their statistics.

Proteomics methods are being applied to synapses, potentially identifying all present proteins (Li, 2007). The Synapse protein DataBase contains about 3,000 human synapse-related proteins (Zhang, Zhang et al., 2007), although it is likely that many of these are not involved in the actual synaptic processing.

Of the proteins coded by the human genome, around 3.2% (988) have been predicted to be regulatory molecules, 2.8% (868) kinases, 5.0% (1543) receptors, 1.2% (376) signalling molecules, and 1.3% (406) ion channels. If the relative proportions are the same among the unknown proteins (41.7%, 12,809), the numbers should be scaled up by 1.4 (VenterAdams et al., 2001). Posttranslational modifications produce on average 3-6 different proteins per gene (Wilkins, Sanchez et al., 1996). This places an upper limit on the number of protein types directly involved in neural signalling and internal signal transduction on the order of 35,000. If all genes were involved we should expect the proteome to be around 158,000 proteins. Later estimates have run up all the way to  $\approx 1$  million proteins (and 600,000 immunoglobulins varying in epitope binding, likely irrelevant for WBE) (Humphery-Smith, 2004), although most estimates appear to tend towards the  $\approx 100,000$  range.

If the requirements for WBE are on the kineome level, then for each involved protein a number of species may be needed, depending on the number of possible phosphorylation, dimerization, carboxylation, or other altered states that exist. In principle, this could lead to a combinatorial explosion of types, requiring storing data for individual protein molecules if the number of functionally relevant kinds is very large.

It is common to simulate cellular regulatory networks using mass action laws and Michaelis-Menten kinetics, although this assumes free diffusion and random collisions. This assumption does not always hold, since molecular mobility inside cells is limited by the properties of the cytoplasm, compartmentalization, and protein anchoring to surfaces. This can be at least partially taken into account by adjusting the equations for "fractal kinetics". Whether fractal kinetics or mass action is valid depends mainly on the probability of reactions (Grima and Schnell, 2006; Schnell and Turner, 2004; Xu and Ding, 2007).

It might also be necessary to model gene expression and other epigenetic mechanisms. Long-term plasticity in neurons requires changes in gene expression, both as response to plasticity-inducing input and in regulating overall plasticity. In addition, gene expression is known to

drive the circadian rhythm, which affects many aspects of brain function (Levenson and Sweatt, 2005; Miller and Sweatt, 2007; McClung and Nestler, 2008). Whether all forms of plasticity or other relevant changes can be simulated with sufficient detail without simulating the gene expression network is currently unknown. If not, then the brain emulation would at the very least have to simulate the contributing gene regulation network and at most a sizeable part of the total network. Gene expression timescales are on the order of minutes to hours, suggesting that the timestep of expression simulation does not have to be as short as for neurons if it is not done on an individual protein level.

## **Learning rules and synaptic adaptation**

A WBE without any synaptic change would likely correspond to a severely confused mind, trapped in anterograde amnesia. While working memory may be based on attractor states of neural activity in the prefrontal cortex and some forms of priming and habituation plausibly are based on synaptic adaptation and calcium build-up, long-term memory formation requires changes in the strength (and possibly connectivity) of synapses.

Synaptic learning has been extensively studied in computational neuroscience, starting with Donald Hebb's 1949 suggestion that co-occurring neural firing initiated long-term change. Since then models on all levels of abstraction have been studied, ranging from the completely abstract to detailed synaptic biochemistry.

Many network models include various synaptic learning rules. There is a wide variety of rules used, ranging from simple Hebbian rules with no state beyond the current weight, over the "BCM-rule" accounting for LTP/LTD-effects in rate-coding neurons (Bienenstock, Cooper et al., 1982) and STDP that counts time differences between spikes (Senn, Markram et al., 2001), to detailed signal transduction models that include 30+ substances (Kikuchi, Fujimoto et al., 2003; Bhalla and Iyengar, 1999).

Synapses also show various forms of adaptation to repeated firing, including both facilitation and depression, which in turn can affect the network dynamics in ways that appear likely to have behaviourally relevant consequences (Thomson, 2000). Various models have been constructed of how synaptic 'resources' are depleted and replenished (Tsodyks, Pawelzik et al., 1998). Such models usually include a few extra state variables in the synapses and time constants for them.

For WBE it is important to keep the number of state variables and local parameters low in synapses, since they dominate the storage demands for neural/compartment models of the brain. At present, we do not have a firm estimate of how complex synapses need to be in order to reproduce the full range of plasticity observed. It is very likely that simple weight-based models are too simple and that models with a handful of state variables cover most observed phenomena. Whether the full transduction cascade needs to be simulated is unclear. On the plus side, this is an area that has been subject to intense modelling and research on multiple scales for several decades and very accessible to experimental testing. Progress in synaptic modelling may be a good indicator of neuroscience understanding.

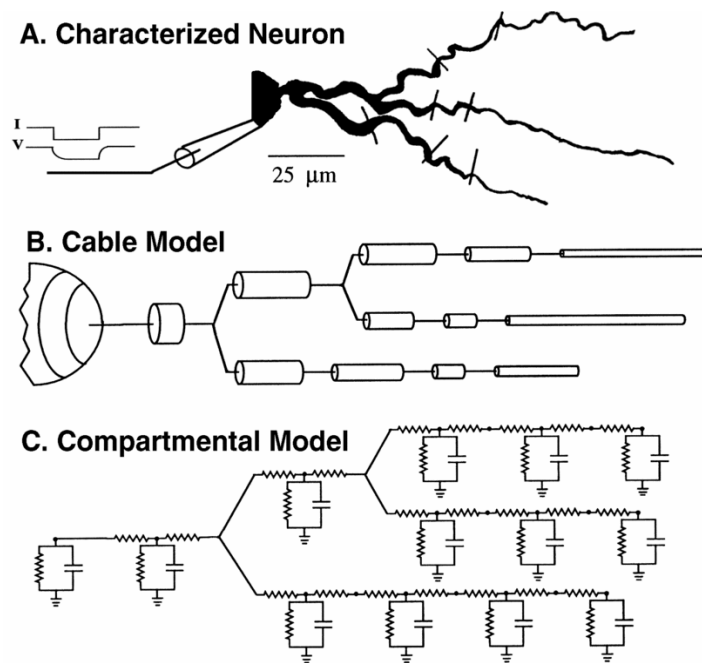
## **Neural models**

The first neural model was the McCulloch-Pitts neuron, essentially binary units summing weighted inputs and firing (i.e. sending 1 rather than 0 as output) if the sum was larger than a threshold (Hayman, 1999; McCulloch and Pitts, 1943). This model and its continuous state

successors form the basis of most artificial neural network models. They do not have any internal state except the firing level. Their link to real biology is somewhat tenuous, although as an abstraction they have been very fruitful.

More realistic models such as “integrate-and-fire” sum synaptic potentials and produce spikes.

Single cell-modelling can be done on roughly five levels of abstraction (Herz, Gollisch et al., 2006): as black box modules that generate probabilistic responses to stimuli according to some probability distribution, as a series of linear or nonlinear filters of signals, as a single compartment with ionic conductances, as a reduced compartment model (few compartments) or as a detailed compartmental model. The more abstract models are theoretically and computationally tractable and have fewer degrees of freedom, while the more detailed models are closer to biological realism and can be linked to empirical data. According to (Herz, Gollisch et al., 2006), most task-specific computation of known direct biological relevance can be achieved by reduced compartmental models, with the possible exception of some forms of nonlinear dendritic processing.



**Figure 21: Compartment models of neurons usually begin with an electrophysiologically characterized neuron (A). This can be regarded as a network of electrical cables with individual properties (B). These are then subdivided into isopotential compartments. The system can then be modeled as an equivalent electronic network (C). Each ion channel type corresponds to a pair of parallel-connected potentials and variable resistances per compartment. Compartment simulations numerically simulate the equivalent network<sup>8</sup>. Image from (Bower and Beeman, 1998)**

Conductance-based models are the simplest biophysical representation of neurons, representing the cell membrane as a capacitor and the different ion channels as (variable) resistances. Neurons or parts of neurons are replaced by their equivalent circuits, which are

<sup>8</sup> See <http://www.brains-minds-media.org/archive/222> for a tutorial in this methodology.

then simulated using ordinary differential equations<sup>9</sup>. Beside the membrane potential they have (at least) two gating variables for each membrane current as dynamical variables.

The core assumptions in conductance-based models are that different ion channels are independent of each other; the gating variables are independent of each other, depending only on voltage (or other factors such as calcium), first order kinetics in the gating variables; and that the region being simulated is isopotential.

More complex ion channel models with internal states in the channels have been developed, as well as models including calcium dynamics (possibly with several forms of calcium buffering).

In simple neuron models, the “neuronic” (firing rate update) equations can be uncoupled from the “mnemonic” (synaptic weight update) equations, the “adiabatic learning hypothesis” (Caianiello, 1961). However, realistic models often include a complex interplay at synapses between membrane potential, calcium levels, and conductances that make this uncoupling difficult to preserve.

A common guideline in modelling is to use compartments 1/10 to 1/20 of the length constant<sup>10</sup> of the dendrite (or axon), making potential differences between compartments differ just by  $\approx 5\%$ . Typical length constants are on the order of 2-5 mm, giving compartments smaller than 200-100  $\mu\text{m}$ . In heavily branching neurons, the short distance between branches forces finer resolution, on the order of 10  $\mu\text{m}$  or less. It can therefore be expected that the majority of compartments will be due to cortical arbors rather than the long axons through the white matter.

The number of state variables of a neuron at least scales with the number of synapses since each synapse has its own dynamics. The number of synapses is also a rough estimate of the number of compartments needed for an accurate morphological model. Each compartment has to store a list of neighbour compartments, dynamical variables, and local parameters. Synapses can be treated as regular compartments with extra information about weight, neurotransmitters, and internal chemical state. A synapse-resolution compartment model of  $10^{11}$  neurons with on the order of  $10^4$  compartments would require  $10^{15}$  compartments.

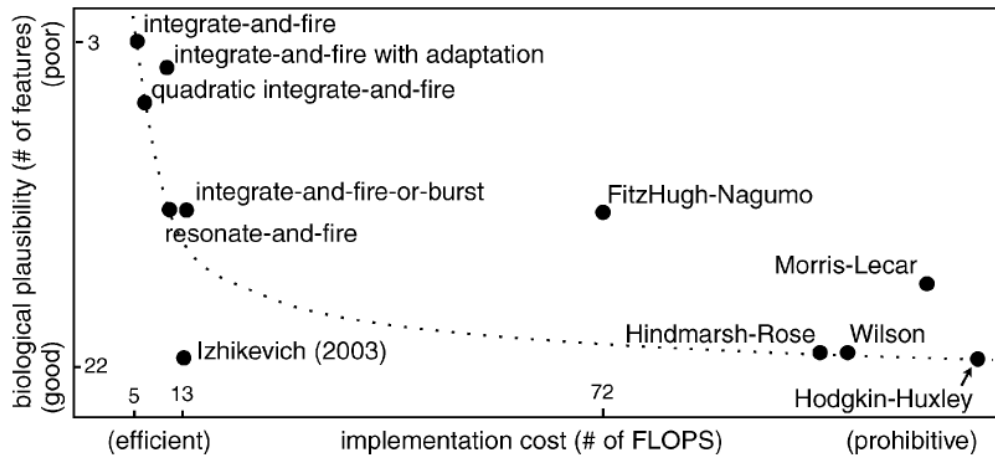
If states in extracellular space matter (e.g. due to volume transmission, ephaptic signals or neurogenesis), it may be necessary to divide the simulation into a spatial grid rather than compartments following the neurons. A volume-based simulation where the brain is divided into size  $r$  voxels would encompass  $1.4 \cdot 10^{-3}/r^3$  voxels. Each voxel would contain information about which cells, compartments, and other information that existed inside, as well as a list of the dynamical variables (local electric fields, chemical concentrations) and local parameter values. For 10  $\mu\text{m}$  side voxels there would be  $1.4 \cdot 10^{18}$  voxels in a human brain.

---

<sup>9</sup> This makes the simplifying assumption that the neuron can be divided into isopotential compartments. A more complex model would describe the membrane state by partial differential equations; this would be highly cumbersome. Fortunately there are no currently known phenomena that appears to require such models.

<sup>10</sup> The length constant  $\lambda$  defines how quickly an imposed voltage decays with distance in a passive cable,  $V(x)=V_0 \exp(-x/\lambda)$ ,  $\lambda=\sqrt{((d/4)R_M/RA)}$  where  $d$  is the diameter,  $R_M$  the membrane resistance per square meter and  $RA$  the axial resistance per meter.

## Reduced models



**Figure 22: Computational cost for different neuron models versus biological plausibility. From (Izhikevich, 2004), figure 2.**

(Izhikevich, 2004) reviews both typical neural firing patterns and a number of computational models of spiking neurons. He estimates both the number of possible biological features different models can achieve and how many floating point instructions are needed per ms of simulation (only assuming a soma current, not taking the effects of dendrites and synapses into account<sup>11</sup>):

**Table 7: Neuron model costs**

Model	# of biological features	FLOPS/ms
Integrate-and-fire	3	5
Integrate-and-fire with adapt.	5	10
Integrate-and-fire-or-burst	10	13
Resonate-and-fire	12	10
Quadratic integrate-and-fire	6	7
Izhikevich (2003)	21	13
FitzHugh-Nagumo	11	72
Hindmarsh-Rose	18	120
Morris-Lecar	14*	600
Wilson	15	180
Hodgkin-Huxley	19*	1200

\* Only the Morris-Lecar and Hodgkin-Huxley models are “biophysically meaningful” in the sense that they attempt actually to model real biophysics, the others only aim for a correct phenomenology of spiking.

The (Izhikevich, 2003) model is interesting since it demonstrates that it may be possible to improve the efficiency of calculations significantly (two orders of magnitude) without losing too many features of the neuron activity. The model itself is a two-variable dynamical system with two model parameters. It was derived from the Hodgkin-Huxley equations using a bifurcation analysis methodology keeping the geometry of phase-space intact (Izhikevich, 2007). While it is not directly biophysically meaningful, it—or similar reduced models of full biophysics—may be possible computational shortcuts in brain emulation. Whether such reductions can be done depends on whether or not the details on internal neural biophysics are important for network-relevant properties such as exact spike-timing. It may also be

<sup>11</sup> To a first approximation each compartment would require the same number of FLOPS making a multicompartment model about 3-4 orders of magnitude more demanding.

possible to apply reduction methods on sub-neural models, but the approach requires an understanding of the geometry of phase space of the system.

## Simulators

There exist numerous simulation systems at present. Some of the more common are GENESIS (GEneral NEural SIMulation System) (Wilson, Bhalla et al., 1989; Bower and Beeman, 1998) and Neuron (Carnevale and Hines, 2006). For a review and comparisons, see (Brette, Rudolph et al., 2007).

Key issues for neural simulators are numerical stability, extendability and parallelizability. The numerical methods used to integrate conductance-based models need to both produce accurate approximation of solutions of the governing equations and run fast. This is made more problematic by the stiffness of some of the equations. Most neural simulators have been designed to be easy to extend with new functions, often producing very complex software systems. For WBE, this might not be necessary once the basic neuroscience has been elucidated. Neural simulators need to be able to run on parallel computers to reach high performance (see section below). This is a key need for WBE.

## Parallel simulation

Networks, neurons, and compartments are in general just linked to nearby entities and act simultaneously, making brain models naturally suited for parallel simulations. The main problem is finding the right granularity of the simulation (i.e. how many and which entities to put on each processing node) so that communications overhead is minimized, or finding communications methods that allow the nodes to communicate efficiently.

Simulations can be time-driven or event-driven. A time-driven simulation advances one timestep at a time while an event-driven simulation keeps a queue of future events (such as synaptic spikes arriving) and advances directly to the next. For some neural network models, such as integrate-and-fire, the dynamics between spikes can be calculated exactly, allowing the simulation efficiently just to jump forward in time to when the next spike occurs (Mattia and Giudice, 2000). However, for highly connected networks the times between the arrivals of spikes become very short, and time-driven simulations are equally efficient. On the other hand, the timestep for time-driven models must be short enough that the discretization of spike timing to particular timesteps does not disrupt timing patterns, or various techniques for keeping sub-timestep timing information must be employed in the simulation (Morrison, Mehring et al., 2005).

Following (Brette, Rudolph et al., 2007), the computational cost per second of biological time is of order  $c_u N/dt + c_p F \cdot N \cdot p$  for time-driven simulations and  $(c_u + c_s + c_q) \cdot F \cdot N \cdot p$  for event driven simulations.  $c_u$  is the cost per update,  $c_p$  the cost for one spike propagation (assumed to be smaller than the update cost),  $c_q$  the cost of enqueueing/dequeueing a spike (assumed to be constant),  $N$  the number of neurons,  $F$  the rate of firing,  $p$  the number of synapses per neuron and  $dt$  the timestep. For  $F=1$  Hz,  $p=10,000$  and  $dt=0.1$  ms, the timestep dependent term of the first equation is likely to dominate: smaller timesteps can increase the computational cost strongly. In the second equation there is no time constant dependency, but the multiplicative term is likely to be large and can suffer if the queue management has a nontrivial cost. The effective time constant in an event-driven simulation is going to be on the order of  $1/Fp$ , making the time- and event-driven simulations about equally fast. If there are gap junctions

or dendro-dendritic interactions the time complexity becomes much higher (Brette, Rudolph et al., 2007).

Well-implemented simulations tends to scale linearly with number of processors, although various memory and communications bottlenecks may occur and optimal use of caching can give even superlinear speedup for some problem sizes (Djurfeldt, Johansson et al., 2005; Migliore, Cannia et al., 2006). The main problem appears to be high connectivity, since inter-processor communications are a major bottleneck. Keeping communications to a minimum, for example by only sending information about when and where a spike has occurred (Johansson and Lansner, 2007) or running dendritic sub-trees on the same processor (Hines, Markram et al., 2008), improves performance significantly. If brain emulation requires more information than this to flow between processing nodes performance will be lower than these examples.

## Current large-scale simulations

Representative current large-scale brain simulations include the following (see also Appendix C for further examples).

A simulation of 16 Purkinje cells with 4,500 compartments receiving input from 244,000 granule cells took 2.5 hours on a 128-processor Cray 3TE (nominally 76.8 GFLOPS) to calculate 2 seconds of simulated activity (Howell, Dyhrfeldt-Johnsen et al., 2000). This implies around 0.3 MFLOPS per neuron<sup>12</sup> and a slowdown factor of 4,500.

The Blue Brain Project aims at modelling mammalian brains at various scales and levels, in particular modelling a complete cortical column in biological detail (Markram, 2006). The cortical column uses about 10,000 morphologically complex neurons connected with 10<sup>8</sup> synapses on an 8,000 processor BlueGene supercomputer.

The so far (2006) largest simulation of a full Hodgkin-Huxley neuron network was performed on the IBM Watson Research Blue Gene supercomputer using the simulator SPLIT (Hammarlund and Ekeberg, 1998; Djurfeldt, Johansson et al., 2005). It was a model of cortical minicolumns, consisting of 22 million 6-compartment neurons with 11 billion synapses, with spatial delays corresponding to a 16 cm<sup>2</sup> cortex surface and a simulation length of one second real-time. Most of the computational load was due to the synapses, each holding 3 state variables<sup>13</sup>. The overall nominal computational capacity used was 11.5 TFLOPS, giving 0.5 MFLOPS per neuron or 1045 FLOPS per synapse. Simulating one second of neural activity took 5,942 s<sup>14</sup>. The simulation showed linear scaling in performance with the number of processors up to 4,096 but began to show some (23%) overhead for 8,192 processors (Djurfeldt, Lundqvist et al., 2006).

A simulation involving 8 million simple spiking Izhikevich neurons with 6,300 synapse/cell with a low firing rate and STDP achieved a slowdown of just 10 on a 4,096 processor Blue Gene supercomputer. This was achieved by both optimizing the synaptic updates and by reducing the number of inter-processor messages by collecting all spikes from a given node that were sent to another node into a single message (Frye, Ananthanarayanan et al., 2007).

---

<sup>12</sup> This also includes overhead. The Purkinje cell models used significantly more computations per neuron than the granule cell models.

<sup>13</sup> Conductance, depression and facilitation.

<sup>14</sup> Mikael Djurfeldt, personal communication.

An even larger simulation with  $10^{11}$  neurons and  $10^{15}$  synapses was done in 2005 by Eugene M. Izhikevich on a Beowulf cluster with 27 3 GHz processors (Izhikevich, 2005). This was achieved by not storing the synaptic connectivity but by generating it whenever it was needed, making this model rather ill suited for brain emulation. One second of simulation took 50 days, giving a slowdown factor of 4.2 million.

(Johansson and Lansner, 2007) estimate the computational demands for simulating the mammalian neocortex of different species, based on a particular model of its function. Assuming that minicolumns organized into hypercolumns are the computational units and that these communicate through spike trains and using a cluster architecture, they show that it is feasible to run a network of intermediate size between rat and cat on a current supercomputer cluster. They claim that using this kind of high-level network (and assuming continued linear scaling) a macaque-sized cortex could be run on a Blue Gene/L in real-time.

## Conclusion

Current neural simulations tend to have neuron numbers and structures fitted to the available computers (in particular in terms of connectivity). This is important for the linear scaling of speed with processor number and gives a performance improvement at the expense of generality. WBE-scale computing will likely have a computational granularity fitted to the structure of the brain, unless the computational power available is so large that inefficiencies due to a loose fit are irrelevant.

Models are currently not driven by scanned data, and individual variations in neuron properties are generated by drawing from a pre-set random distribution. While this allows models that generate needed parameters only when required and hence avoid storing them, this is relatively rare and most implementations do use stored parameters. Hence there does not seem to be any difference between storage requirements for WBE models and random models, assuming the same underlying parameters and structure.

The speedup of different networks ranges over six orders of magnitude, but most are a hundredfold to a thousandfold slower than biology, and a few are close to real-time. This is likely more due to research practice than any inherent limitation: model sizes are selected so that they fit available computing power. The length of the simulation is set to produce data comparable to some biological measurement (which, for neural networks, tend to be a few seconds long for neurocognitively interesting cases), and the length of simulation time corresponds to what constitutes an acceptable turnaround time for a computer centre or an office computer. Smaller simulations can run faster until they hit bottlenecks set by inter-processor communications speed. It is hence likely that even early WBE will be close to real-time, with computational constraints – rather than speed – limiting the length of the simulation.

We clearly today have computational capabilities sufficient to simulate many invertebrate brains (such as snails, ants, and fruit flies) using compartment models on parallel clusters of modest size. Small mammalian brains appear computationally within reach.

Given the differences between models, implementation, computers and other parameters it is hard to reliably compare current large-scale models to estimate trends. There is also a lack of historical data, as only recently large models have become practically possible. Hence a conservative estimate assumes that the models will grow based solely on computer power



and not on any algorithmic improvement. If models reliably expressing sublinear computational demands appear, they would likely make large-scale computer power irrelevant as a limiting factor for WBE.

The major computational load scales with the number of synapses or (for compartment models) compartments, since they are the most numerous entities. Hence, one likely useful metric would be the number of synaptic updates per second, as well as the computational demands per synapse.

## *Body simulation*

The body simulation translates between neural signals and the environment, as well as maintains a model of body state as it affects the brain emulation.

How detailed the body simulation needs to be in order to function depends on the goal. An “adequate” simulation produces enough and the right kind of information for the emulation to function and act, while a convincing simulation is nearly or wholly indistinguishable from the “feel” of the original body.

A number of relatively simple biomechanical simulations of bodies connected to simulated nervous systems have been created to study locomotion. (Suzuki, Goto et al., 2005) simulated the *C. elegans* body as a multi-joint rigid link where the joints were controlled by motoneurons in a simulated motor control network. Örjan Ekeberg has simulated locomotion in lamprey (Ekeberg and Grillner, 1999), stick insects (Ekeberg, Blümel et al., 2004), and the hind legs of cat (Ekeberg and Pearson, 2005) where a rigid skeleton is moved by muscles either modeled as springs contracting linearly with neural signals, or in the case of the cat, a model fitting observed data relating neural stimulation, length, and velocity with contraction force (Brown, Scott et al., 1996). These models also include sensory feedback from stretch receptors, enabling movements to adapt to environmental forces: locomotion involves an information loop between neural activity, motor response, body dynamics, and sensory feedback (Pearson, Ekeberg et al., 2006).

Today biomechanical model software enables fairly detailed models of muscles, the skeleton, and the joints, enabling calculation of forces, torques, and interaction with a simulated environment (Biomechanics Research Group Inc, 2005). Such models tend to simplify muscles as lines and make use of pre-recorded movements or tensions to generate the kinematics.

A detailed mechanical model of human walking has been constructed with 23 degrees of freedom driven by 54 muscles. However, it was not controlled by a neural network but rather used to find an energy-optimizing gait (Anderson and Pandy, 2001). A state-of-the-art model involving 200 rigid bones with over 300 degrees of freedom, driven by muscular actuators with excitation-contraction dynamics and some neural control, has been developed for modelling human body motion in a dynamic environment, e.g. for ergonomics testing (Ivancevic and Beagley, 2004). This model runs on a normal workstation, suggesting that rigid body simulation is not a computationally hard problem in comparison to WBE.

Other biomechanical models are being explored for assessing musculoskeletal function in human (Fernandez and Pandy, 2006), and can be validated or individualized by use of MRI data (Arnold, Salinas et al., 2000) or EMG (Lloyd and Besier, 2003). It is expected that near future models will be based on volumetric muscle and bone models found using MRI scanning (Blemker, Asakawa et al., 2007; Blemker and Delp, 2005), as well as construction of topological models (Magenat-Thalmann and Cordier, 2000). There are also various simulations of soft tissue (Benham, Wright et al., 2001), breathing (Zordan, Celly et al., 2004) and soft tissue deformation for surgery simulation (Cotin, Delingette et al., 1999).

Another source of body models comes from computer graphics, where much effort has gone into rendering realistic characters, including modelling muscles, hair and skin. The emphasis has been on realistic appearance rather than realistic physics (Scheepers, Parent et al., 1997), but increasingly the models are becoming biophysically realistic and overlapping with

biophysics (Chen and Zeltzer, 1992; Yucesoy, Koopman et al., 2002). For example, 30 contact/collision coupled muscles in the upper limb with fascia and tendons were generated from the visible human dataset and then simulated using a finite volume method; this simulation (using one million mesh tetrahedra) ran at a rate of 240 seconds per frame on a single CPU Xeon 3.06 GHz (on the order of a few GFLOPS) (Teran, Sifakis et al., 2005). Scaling this up 20 times to encompass  $\approx 600$  muscles implies a computational cost on the order of a hundred TFLOPS for a complete body simulation.

Physiological models are increasingly used in medicine for education, research and patient evaluation. Relatively simple models can accurately simulate blood oxygenation (Hardman, Bedforth et al., 1998). For a body simulation this might be enough to provide the right feedback between exertion and brain state. Similarly simple nutrient and hormone models could be used insofar a realistic response to hunger and eating were desired.

## **Conclusion**

Simulating a realistic human body is kinematically possible today, requiring computational power ranging between workstations and mainframes. For simpler organisms such as nematodes or insects correspondingly simpler models could (and have) been used. Since the need for early WBE is merely adequate body simulation, the body does not appear to pose a major bottleneck.

However, since many motor actions involve a rich interplay between mechanics and nerve signals it should not be surprising if relatively complex models are needed for apparently simple actions such as standing or walking. Newly started emulations may need time and effort to learn to use their unfamiliar bodies.

## *Environment simulation*

The environment simulation provides a simulated physical environment for the body simulation. One can again make the distinction between an adequate environment simulation and a convincing simulation. An adequate environment produces enough input to activate the brain emulation and allow it to interact in such a way that its state and function can be evaluated. A convincing simulation is close enough to reality that the kinds of signals and interaction that occurs is hard (or impossible) for the emulated being to distinguish from reality.

It seems likely that we already have the tools for making adequate environments in the form of e.g. game 3D rendering engines with physics models or virtual environments such as *Second Life*. While not covering more than sight and sound, they might be enough for testing and development. For emulations of simpler brains such as *C. elegans* simulations with simplified hydrodynamics (similar to (Ekeberg and Grillner, 1999)) may be enough, possibly extended with simulated chemical gradients to guide behaviour.

Convincing environments might be necessary only if the long-term mental well-being of emulated humans (or other mammals) is at stake. While it is possible that a human could adapt to a merely adequate environment, it seems likely that it would experience such an environment as confining or lacking in sensory stimulation. Note that even in a convincing environment simulation not all details have to fit physical reality perfectly (Bostrom, 2003). Plausible simulation is more important than accurate simulation in this domain and may actually improve the perceived realism (Barzel, Hughes et al., 1996). In addition, humans accept surprisingly large distortions (20% length change of objects when not paying direct attention, 3% when paying attention (Harrison, Rensink et al., 2004)), allowing a great deal of leeway in constructing a convincing environment.

What quality of environment is needed to completely fool the senses? In the following we will assume that the brain emulation runs in real-time, i.e., that one second of simulation time corresponds to one second of outside time. For slower emulations, the environment model would be slowed comparably, and all computational demands divided by the scale factor.

At the core of the environment model would be a physics engine simulating the mechanical interactions between the objects in the environment and the simulated body. It would not only update object positions depending on movement and maintain a plausible physics, it would also provide collision and contact information needed for simulated touch. On top of this physics simulation a series of rendering engines for different senses would produce the raw data for the senses in the body model.

### **Vision**

Visual photorealism has been sought in computer graphics for about 30 years, and this appears to be a fairly mature area at least for static images and scenes. Much effort is currently going into such technology, for use in computer games and movies.

(McGuigan, 2006) proposes a “graphics Turing test” and estimates that for 30 Hz interactive visual updates 518.4-1036.8 TFLOPS would be enough for Monte Carlo global illumination. This might actually be an overestimate since he assumes generation of complete pictures. Generating only the signal needed for the retinal receptors (with higher resolution for the

fovea than the periphery) could presumably reduce the demands. Similarly, more efficient implementations of the illumination model (or a cheaper one) would also reduce demands significantly.

## Hearing

The full acoustic field can be simulated over the frequency range of human hearing by solving the differential equations for air vibration (Garriga, Spa et al., 2005). While accurate, this method has a computational cost that scales with the volume simulated, up to 16 TFLOPS for a 2×2×2 m room. This can likely be reduced by the use of adaptive mesh methods, or ray- or beam-tracing of sound (Funkhouser, Tsingos et al., 2004).

Sound generation occurs not only from sound sources such as instruments, loudspeakers, and people but also from normal interactions between objects in the environment. By simulating surface vibrations, realistic sounds can be generated as objects collide and vibrate. A basic model with  $N$  surface nodes requires  $0.5292 N$  GFLOPS, but this can be significantly reduced by taking perceptual shortcuts (Raghuvanshi and Lin, 2006; Raghuvanshi and Lin, 2007). This form of vibration generation can likely be used to synthesize realistic vibrations for touch.

## Smell and Taste

So far no work has been done on simulated smell and taste in virtual reality, mainly due to the lack of output devices. Some simulations of odorant diffusion have been done in underwater environments (Baird RC, Johari H et al., 1996 ) and in the human and rat nasal cavity (Keyhani, Scherer et al., 1997; Zhao, Dalton et al., 2006). In general, an odor simulation would involve modelling diffusion and transport of chemicals through air flow; and the relatively low temporal and spatial resolution of human olfaction would likely allow a fairly simple model. A far more involved issue is what odorant molecules to simulate. Humans have 350 active olfactory receptor genes, but we can likely detect more variation due to different diffusion in the nasal cavity (Shepherd, 2004).

Taste appears even simpler in principle to simulate since it only comes into play when objects are placed in the mouth and then only through a handful of receptor types. However, the taste sensation is a complex interplay between taste, smell, and texture. It may be necessary to have particularly fine-grained physics models of the mouth contents in order to reproduce a plausible eating experience.

## Haptics

The haptic senses of touch, proprioception, and balance are crucial for performing skilled actions in real and virtual environments (Robles-De-La-Torre, 2006).

Tactile sensation relates both to the forces affecting the skin (and hair) and to how they are changing as objects or the body are moved. To simulate touch, stimuli collision detection is needed to calculate forces on the skin (and possibly deformations) as well as the vibrations when it is moved over a surface or exploring it with a hard object (Klatzky, Lederman et al., 2003). To achieve realistic haptic rendering, updates in the kilohertz range may be necessary (Lin and Otaduy, 2005). In environments with deformable objects various nonlinearities in response and restitution have to be taken into account (Mahvash and Hayward, 2004).

Proprioception, the sense of how far muscles and tendons are stretched (and by inference, limb location) is important for maintaining posture and orientation. Unlike the other senses, proprioceptive signals would be generated by the body model internally. Simulated Golgi organs, muscle spindles, and pulmonary stretch receptors would then convert body states into nerve impulses.

The balance signals from the inner ear appears relatively simple to simulate, since it is only dependent on the fluid velocity and pressure in the semicircular channels (which can likely be assumed to be laminar and homogeneous) and gravity effects on the utricle and saccule. Compared to other senses, the computational demands are minuscule.

Thermoreception could presumably be simulated by giving each object in the virtual environment a temperature, activating thermoreceptors in contact with the object. Nociception (pain) would be simulated by activating the receptors in the presence of excessive forces or temperatures; the ability to experience pain from simulated inflammatory responses may be unnecessary verisimilitude.

## **Conclusion**

Rendering a convincing environment for all senses probably requires on the order of several hundred TFLOPS. While significant by today's standards, this represents a minuscule fraction of the computational resources needed for brain emulation, and is not necessary for meeting the basic success criteria of emulation.

## Computer requirements

WBE requires significant computer power and storage for image processing and interpretation during the scanning process, and to hold and run the resulting emulation. Both problems appear to be strongly parallelizable.

A way of estimating the distance between current capabilities and those needed for human WBE is to estimate the number of entities/state variables needed to specify the emulation, the required time resolution, and compare this to trends in computer hardware. This will depend on what level of detail a WBE can be achieved at; full molecular simulation would require vastly more computational power than a model using simplified neurons. For a given level of simulation, we can then estimate the earliest possible date—*assuming that Moore's law continues unchanged*—when that kind of emulation will be possible for a given amount of money.

Appendix B analyses current computing trends in detail. The main conclusion is that memory per dollar increases one order of magnitude per 4.8 years and processing power per dollar increases one order of magnitude per 3.7, 3.9 or 6.4 years depending on whether one bases the prediction on supercomputer price/performance, supercomputer power or commodity computers. We will use the optimistic supercomputer estimate and the more cautious commodity estimates to get an overall range.

It should be noted that the estimates below make merely order of magnitude estimates of the number of entities and complexity of their storage; they are quite debatable. However, given that an order of magnitude complexity increase only adds circa 5 years to the estimate, exact numbers are not necessary. We are also ignoring body and environment simulation because, as shown in the next sections, they likely require only a fraction of the brain emulation computations.

**Table 8: Storage demands (emulation only, human brain)**

Level		# entities	Bytes per entity	Memory demands (Tb)	Earliest year, \$1 million
1	Computational module	100-1,000?	?	?	?
2	Brain region connectivity	10 <sup>5</sup> regions, 10 <sup>7</sup> connections	3? (2-byte connectivity, 1 byte weight)	3·10 <sup>-5</sup>	Present
3	Analog network population model	10 <sup>8</sup> populations, 10 <sup>13</sup> connections.	5 (3-byte connectivity, 1 byte weight, 1 byte extra state variable)	50	Present
4	Spiking neural network	10 <sup>11</sup> neurons, 10 <sup>15</sup> connections.	8 (4-byte connectivity, 4 state variables)	8,000	2019
5	Electrophysiology	10 <sup>15</sup> compartments x 10 state variables = 10 <sup>16</sup> .	1 byte per state variable	10,000	2019
6	Metabolome	10 <sup>16</sup> compartments x 10 <sup>2</sup> metabolites = 10 <sup>18</sup> .	1 byte per state variable	10 <sup>6</sup>	2029
7	Proteome	10 <sup>16</sup> compartments x 10 <sup>3</sup> proteins and metabolites = 10 <sup>19</sup> .	1 byte per state variable	10 <sup>7</sup>	2034
8	States of protein complexes	10 <sup>16</sup> compartments x 10 <sup>3</sup> proteins x 10 states = 10 <sup>20</sup>	1 byte per state variable	10 <sup>8</sup>	2038
9	Distribution of	10 <sup>16</sup> compartments x 10 <sup>3</sup>	1 byte per state	10 <sup>9</sup>	2043

	complexes	proteins and metabolites x 100 states/locations.	variable		
	Full 3D EM map (Fiala, 2002)	50x2.5x2.5 nm	1 byte per voxel, compressed.	10 <sup>9</sup>	2043
10	Stochastic behaviour of single molecules	10 <sup>25</sup> molecules	31 (2 bytes molecule type, 14 bytes position, 14 bytes velocity, 1 byte state)	3.1·10 <sup>14</sup>	2069
11	Quantum	Either ≈10 <sup>26</sup> atoms, or smaller number of quantum-state carrying molecules.	Qbits	?	?

For the case of a “Manhattan project” spending \$10<sup>9</sup>, subtract 14.4 years from these estimates.

**Table 9: Processing demands (emulation only, human brain)**

Level		# entities	FLOPS per entity	Time-steps per second	CPU demand (FLOPS)	Earliest year, \$1 million (commod- ity computer estimate)	Earliest year, \$1 million (Super- computer estimate)
1	Computational module	100-1,000?	?	?	?	?	?
2	Brain region connectivity	10 <sup>5</sup> regions, 10 <sup>7</sup> connections	?	?	?	?	?
3	Analog network population model	10 <sup>8</sup> populations, 10 <sup>13</sup> connections	1	10 <sup>2</sup>	10 <sup>15</sup>	2023	2008 <sup>15</sup>
4	Spiking neural network	10 <sup>11</sup> neurons, 10 <sup>15</sup> connections	10	10 <sup>3</sup>	10 <sup>18</sup>	2042	2019
5	Electrophysiol ogy	10 <sup>15</sup> compartments x 10 state variables = 10 <sup>16</sup> .	10 <sup>3</sup> FLOPS per ms per compart ment.	10 <sup>4</sup>	10 <sup>22</sup>	2068	2033
6	Metabolome	10 <sup>16</sup> compartments x 10 <sup>2</sup> metabolites= 10 <sup>18</sup> .	10 <sup>3</sup>	10 <sup>4</sup>	10 <sup>25</sup>	2087	2044
7	Proteome	10 <sup>16</sup> compartments x 10 <sup>3</sup> proteins and metabolites = 10 <sup>19</sup> .	10 <sup>3</sup>	10 <sup>4</sup>	10 <sup>26</sup>	2093	2048
8	States of protein complexes	10 <sup>16</sup> compartments x 10 <sup>3</sup> proteins x 10 states = 10 <sup>20</sup>	10 <sup>3</sup>	10 <sup>4</sup>	10 <sup>27</sup>	2100	2052
9	Distribution of	10 <sup>16</sup>	10 <sup>3</sup>	10 <sup>6</sup>	10 <sup>30</sup>	2119	2063

<sup>15</sup> “Roadrunner” at Los Alamos National Laboratory achieved 1.7 petaflops on May 25, 2008.



	complexes	compartments x 10 <sup>3</sup> proteins and metabolites x 100 states per location = 10 <sup>21</sup> .					
10	Stochastic behavior of single molecules	10 <sup>25</sup> molecules	10 <sup>3</sup>	10 <sup>15</sup>	10 <sup>43</sup>	2201	2111
11	Quantum	Either ≈10 <sup>26</sup> atoms, or smaller number of quantum-state carrying molecules.	Qbits	10 <sup>13</sup> -10 <sup>20</sup>	?	?	?

For the case of a “Manhattan project” spending \$10<sup>9</sup>, subtract 19.1/11.1 years from these estimates, respectively.

A rough estimate for simpler brains is that a macaque brain has 14% of the human synapses, cat brains 3%, rat 0.26%, mouse 0.1% (Johansson and Lansner, 2007). Assuming simulation demands scale by synapse number (likely for compartment models) this means macaque emulations on a given level can be achieved 5.4/3.2 years earlier, cat emulations 9.7/5.6 years, rat emulations 16/9.6 years and mouse emulations 19/11 (depending on which column above is used). Emulations of honey bees (950,000 neurons) and *aplysia* (20,000) appear feasible today at a fairly high scale (51/30, 61/36 years earlier respectively). A slower decade time of computer improvement produces a longer gap between animal emulations and human emulations.

## Conclusions

It appears feasible within the foreseeable future to store the full connectivity or even multistate compartment models of all neurons in the brain within the working memory of a large computing system.

Achieving the performance needed for real-time emulation appears to be a more serious computational problem. However, the uncertainties in this estimate are also larger since it depends on the currently unknown number of required states, the computational complexity of updating them (which may be amenable to drastic improvements if algorithmic shortcuts can be found), the presumed limitation of computer hardware improvements to a Moore’s law growth rate, and the interplay between improving processors and improving parallelism<sup>16</sup>. A rough conclusion would nevertheless be that if electrophysiological models are enough, full human brain emulations should be possible before mid-century. Animal models of simple mammals would be possible one to two decades before this.

---

<sup>16</sup> This can be seen in the ongoing debates about whether consumer GPU performance should be regarded as being in the \$0.2 range per GFLOPS; if WBE can be mapped to such high-performance cheap special purpose hardware several orders of magnitude of improvement can be achieved.

## *Validation*

As computer software increased in complexity, previous methods of debugging became insufficient, especially as software development moved from small groups to large projects in large organisations. This led to the development of a number of software testing methodologies aiming at improving quality (Gelperin and Hetzel, 1988). Currently neuroscience appears to be in an early “debugging” paradigm where data and procedures certainly are tested in various ways, but usually just through replication or as an ad hoc activity when something unexpected occurs. For large-scale neuroscience testing and validation methods need to be incorporated in the research process to ensure that the process works, that the data provided to other parts of the research is accurate and that the link between reality and model is firm.

An important early/ongoing research goal would be to quantify the importance of each level of scale of phenomena to the resultant observed higher brain functions of interest. In particular, it is important to know to what level of detail they need to be simulated in order to achieve the same kind of emergent behaviour on the next level. In some cases it might be possible to “prove” this by performing simulations/emulations at different levels of resolution and comparing their results. This would be an important application of early small-scale emulations and would help pave the way for larger ones.

Ideally, a “gold standard” model at the highest possible resolution could be used to test the extent to which it is possible to deviate from this before noticeable effects occur, and to determine which factors are irrelevant for higher-level phenomena. Some of this information may already exist in the literature, some needs to be discovered through new computational neuroscience research. Exploration of model families with different levels of biological detail is already done occasionally.

A complementary approach is to develop manufactured data where the ground truth is known (“phantom datasets”), and then apply reconstruction methods on this data to see how well they can deduce the true network. For example, the NETMORPH system models neurite outgrowth which creates detailed neural morphology and network connectivity (Koene, 2008). This can then be used to make virtual slices. Multiple datasets can be generated to test the overall reliability of reconstruction methods.

## *Discussion*

As this review shows, WBE on the neuronal/synaptic level requires relatively modest increases in microscopy resolution, a less trivial development of automation for scanning and image processing, a research push at the problem of inferring functional properties of neurons and synapses, and relatively business-as-usual development of computational neuroscience models and computer hardware. This assumes that this is the appropriate level of description of the brain, and that we find ways of accurately simulating the subsystems that occur on this level. Conversely, pursuing this research agenda will also help detect whether there are low-level effects that have significant influence on higher level systems, requiring an increase in simulation and scanning resolution.

There do not appear to exist any obstacles to attempting to emulate an invertebrate organism today. We are still largely ignorant of the networks that make up the brains of even modestly complex organisms. Obtaining detailed anatomical information of a small brain appears entirely feasible and useful to neuroscience, and would be a critical first step towards WBE. Such a project would serve as both a proof of concept and a test bed for further development.

If WBE is pursued successfully, at present it looks like the need for raw computing power for real-time simulation and funding for building large-scale automated scanning/processing facilities are the factors most likely to hold back large-scale simulations.

## *Appendix A: Estimates of the computational capacity/demands of the human brain*

The most common approach is a straightforward multiplicative estimate: given the number of neurons, the average number of synapses and an assumed amount of information per synapse or number of operations per second per synapse. This multiplicative method has been applied to microtubuli and proteins too.

However, it still might be necessary to store concentrations of several chemical species, neurotransmitter types and other data if a biologically realistic model is needed (especially the identities of the pre- and postsynaptic neurons). Some estimates of the storage requirements of brain emulation are included in the table below.

Other estimation methods are based on analogy or constraints. (Moravec, 1999) suggested exploiting the known requirements of image processing by equating them with a corresponding neural structure (the retina), and then scaling up the result. (Merkle, 1989a) used energy constraints on elementary neural operations. (Landauer, 1986) attempted an estimation based on experimental psychological memory and signal theory.

Assumption on the order of one bit of information per synapse has some support on theoretical grounds. Models of associative neural networks have an information storage capacity slightly under 1 bit per synapse depending on what kind of information is encoded (Nadal, 1991; Nadal and Toulouse, 1990). Extending the dynamics of synapses for storing sequence data does not increase this capacity (Rehn and Lansner, 2004). Geometrical and combinatorial considerations suggest 3-5 bits per synapse (Stepanyants, Hof et al., 2002; Kalisman, Silberberg et al., 2005). Fitting theoretical models to Purkinje cells suggests that they can reach 0.25 bits/synapse (Brunel, Hakim et al., 2004).

**Table 10: Estimates of computational capacity of the human brain. Units have been converted into FLOPS and bits whenever possible. Levels refer to Table 2.**

Source	Assumptions	Computational demands	Memory
(Leitl, 1995)	Assuming $10^{10}$ neurons, 1,000 synapses per neuron, 34 bit ID per neuron and 8 bit representation of dynamic state, synaptic weights and delays. [Level 5]		$5 \cdot 10^{15}$ bits (but notes that the data can likely be compressed).
(Tuszynski, 2006)	Assuming microtubuli dimer states as bits and operating on nanosecond switching times. [Level 10]	$10^{28}$ FLOPS	$8 \cdot 10^{19}$ bits
(Kurzweil, 1999)	Based on 100 billion neurons with 1,000 connections and 200 calculations per second. [Level 4]	$2 \cdot 10^{16}$ FLOPS	$10^{12}$ bits
(Thagard, 2002)	Argues that the number of computational elements in the brain is greater than the number of neurons, possibly even up to the $10^{17}$ individual protein molecules. [Level 8]	$10^{23}$ FLOPS	
(Landauer, 1986)	Assuming 2 bits learning per second during conscious time, experiment based. [Level 1]		$1.5 \cdot 10^9$ bits ( $10^9$ bits with loss)

(Neumann, 1958)	Storing all impulses over a lifetime.		10 <sup>20</sup> bits
(Wang, Liu et al., 2003)	Memories are stored as relations between neurons.		10 <sup>8432</sup> bits (See footnote 17)
(Freitas Jr., 1996)	10 <sup>10</sup> neurons, 1,000 synapses, firing 10 Hz [Level 4]	10 <sup>14</sup> bits/second	
(Bostrom, 1998)	10 <sup>11</sup> neurons, 5·10 <sup>3</sup> synapses, 100 Hz, each signal worth 5 bits. [Level 5]	10 <sup>17</sup> operations per second	
(Merkle, 1989a)	Energy constraints on Ranvier nodes.	2·10 <sup>15</sup> operations per second (10 <sup>13</sup> -10 <sup>16</sup> ops/s)	
(Moravec, 1999; Morevec, 1988; Moravec, 1998)	Compares instructions needed for visual processing primitives with retina, scales up to brain and 10 times per second. Produces 1,000 MIPS neurons. [Level 3]	10 <sup>8</sup> MIPS	8·10 <sup>14</sup> bits.
(Merkle, 1989a)	Retina scale-up. [Level 3]	10 <sup>12</sup> -10 <sup>14</sup> operations per second.	
(Dix, 2005)	10 billion neurons, 10,000 synaptic operations per cycle, 100 Hz cycle time. [Level 4]	10 <sup>16</sup> synaptic ops/s	4·10 <sup>15</sup> bits (for structural information)
(Cherniak, 1990)	10 <sup>10</sup> neurons, 1,000 synapses each. [Level 4]		10 <sup>13</sup> bits
(Fiala, 2007)	10 <sup>14</sup> synapses, identity coded by 48 bits plus 2x36 bits for pre- and postsynaptic neuron id, 1 byte states. 10 ms update time. [Level 4]	256,000 terabytes/s	2·10 <sup>16</sup> bits (for structural information)
(Seitz)	50-200 billion neurons, 20,000 shared synapses per neuron with 256 distinguishable levels, 40 Hz firing. [Level 5]	2·10 <sup>12</sup> synaptic operations per second	4·10 <sup>15</sup> - 8·10 <sup>15</sup> bits
(Malickas, 1996)	10 <sup>11</sup> neurons, 10 <sup>2</sup> -10 <sup>4</sup> synapses, 100-1,000 Hz activity. [level 4]	10 <sup>15</sup> -10 <sup>18</sup> synaptic operations per second	
	1·10 <sup>11</sup> neurons, each with 10 <sup>4</sup> compartments running the basic Hodgkin-Huxley equations with 1200 FLOPS each (based on (Izhikevich, 2004)). Each compartment would have 4 dynamical variables and 10 parameters described by one byte each.	1.2·10 <sup>18</sup> FLOPS	1.12·10 <sup>28</sup> bits

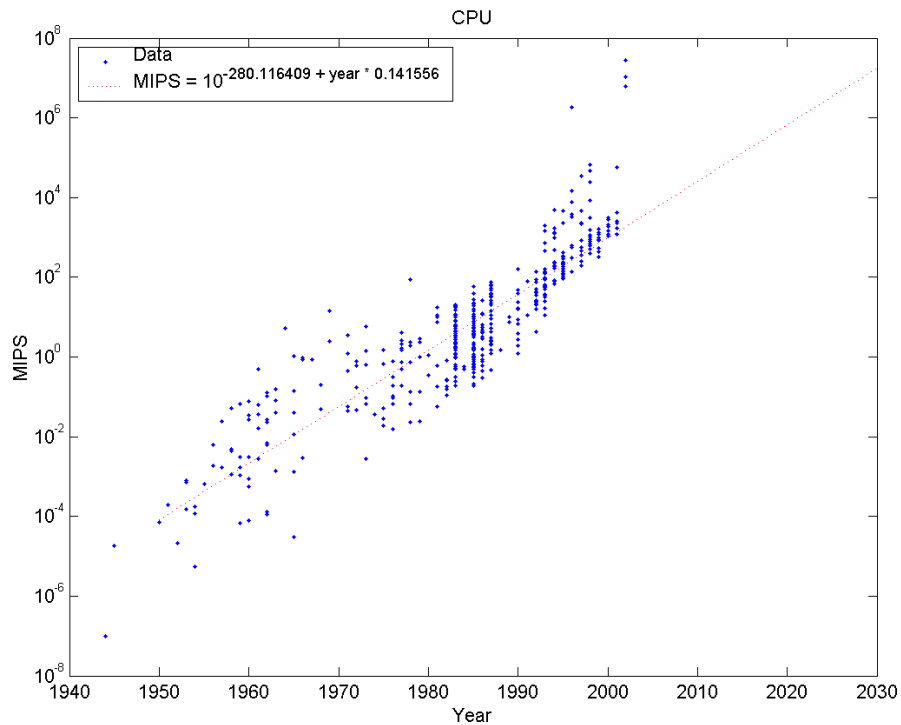
<sup>17</sup> This information density is far larger than the Bekenstein black hole entropy bound on the information content in material systems (Bekenstein, 1981).

## Appendix B: Computer Performance Development

Forecasts of future computer performance are needed to make rough estimates of when brain emulation will become feasible in terms of computer storage and processing capacity. The following estimates are (with two exceptions) based on data from John C. McCallum's datasets of CPU price performance (McCallum, 2003), memory performance (McCallum, 2007b) and disk performance (McCallum, 2007a).

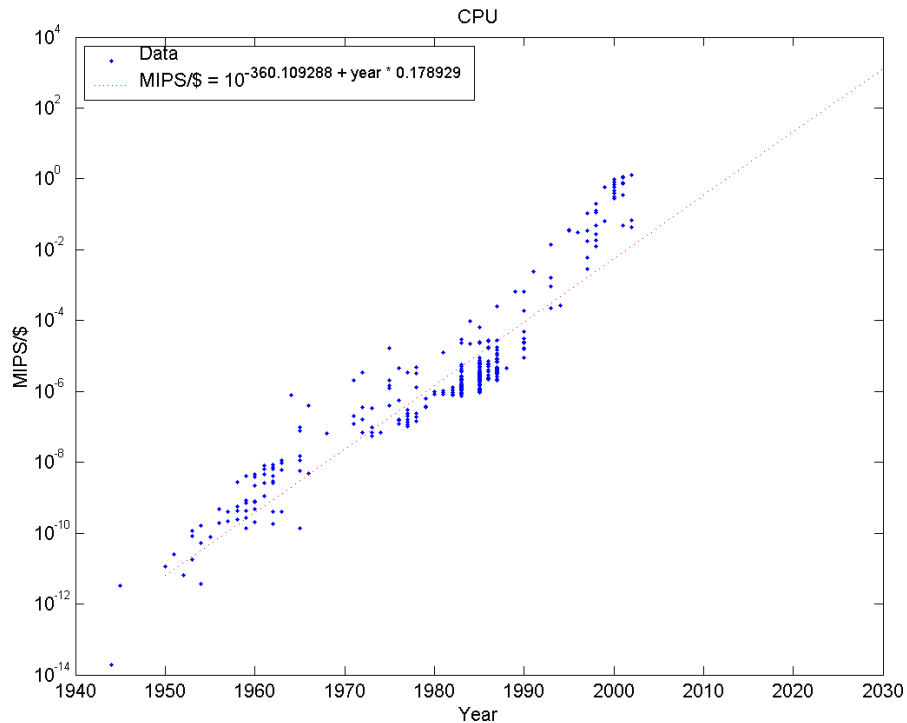
### Processing Power

Plotting the performance of computer systems gives an estimate of available total computer power of unitary, off-the-shelf systems (Figure 23).



**Figure 23: Processing power (MIPS) over time.**

A least squares fit has been made with an exponential curve (straight in this semilog plot). The decade time, the time it takes for an order of magnitude increase in MIPS is  $\approx 7.1$  years.



**Figure 24: Processing power per dollar over time.**

A more relevant measure is the amount of computing power a dollar can buy. Using the data and adjusting for inflation to 2007 dollars (this has been done in all estimates below) we get a decade time of just 5.6 years (Figure 24). The bootstrap 95% confidence interval is 5.3-5.9. Present performance is about 1 MIPS per dollar. The trend appears reliable, but possibly accelerating.

Is the rate of development changing? Fitting curves to 20-year intervals of the MIPS/\$ estimates produces a range of estimates of the development exponent, clustering together into two or three groups. The decade times are roughly 4.4, 8.7 and 3.5 years respectively. The slowest development speed occurred during the 70's and 80's, perhaps due to the proliferation of cheap home computers built with less powerful processors for economical reasons. Since then it has picked up speed again.

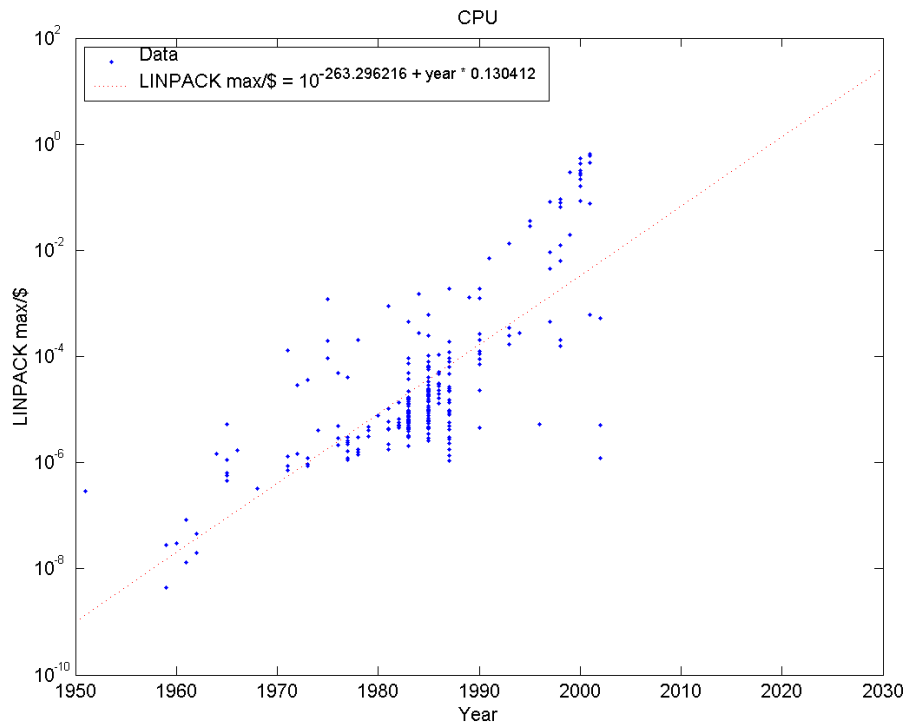
Fitting to computers in the same price classes (prices equal within an order of magnitude) produce decade times ranging from 4.3 to 7.1 years with the cheapest computers becoming more economical fastest. Clearly, the commodity market is driving development fast (but parallelisation has the potential to speed development even further, as described below).

Given these results it looks likely that the trend will continue (for some unknown duration) with a decade time of between 3.5 and 8.7 years, with 5.6 as a middle estimate.

### FLOPS vs. MIPS

These measurements have used MIPS as a measure of computational power, but it is not a reliable indicator of actual performance in numeric-heavy applications (e.g. see (Nordhaus,

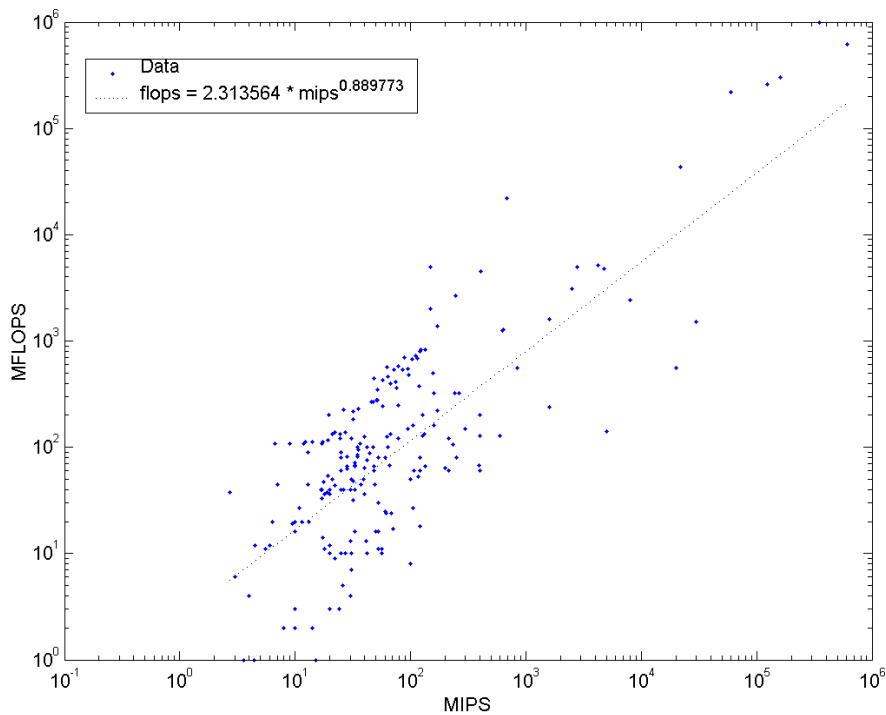
2001) for a criticism). For that, the MFLOPS (Million Floating Point instructions per Second) is more suitable. Unfortunately, it is not as widely tested as the MIPS.



**Figure 25: Linpack performance per dollar over time.**

The floating-point heavy measure maximum LINPACK performance per dollar, produces a graph similar (if noisier) to MIPS (Figure 25). The decade time is 7.7 years, similar to the MIPS estimate but with greater uncertainty (the bootstrap confidence interval is 6.5-9.2 years).

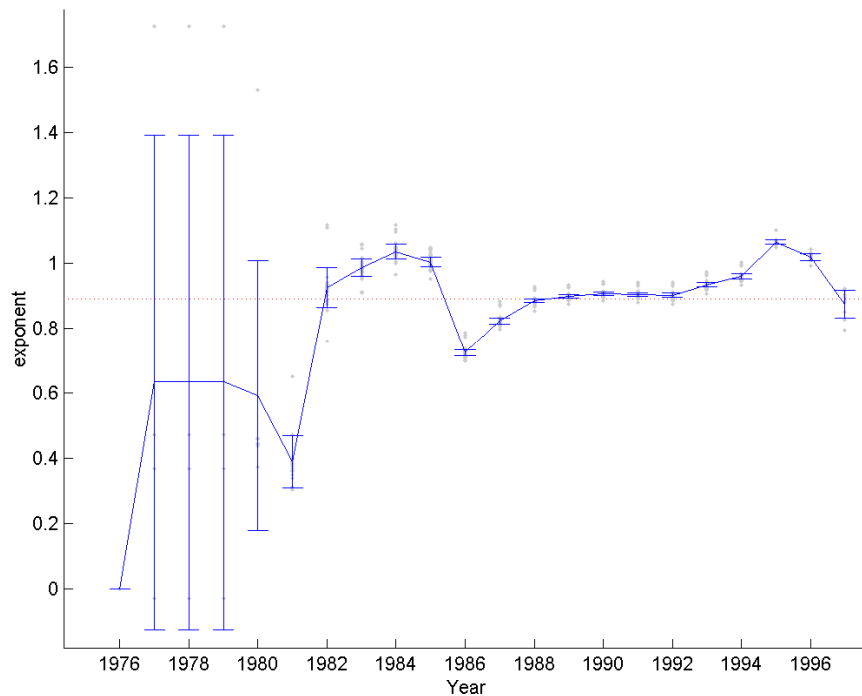




**Figure 26: MIPS vs. MFLOPS.**

The logarithms of estimated MIPS and max FLOPS correlate to 0.79, suggesting a fairly robust link between them. Fitting a relationship suggests that FLOPS scales as MIPS to the power of 0.89, i.e. slightly slower than unity.

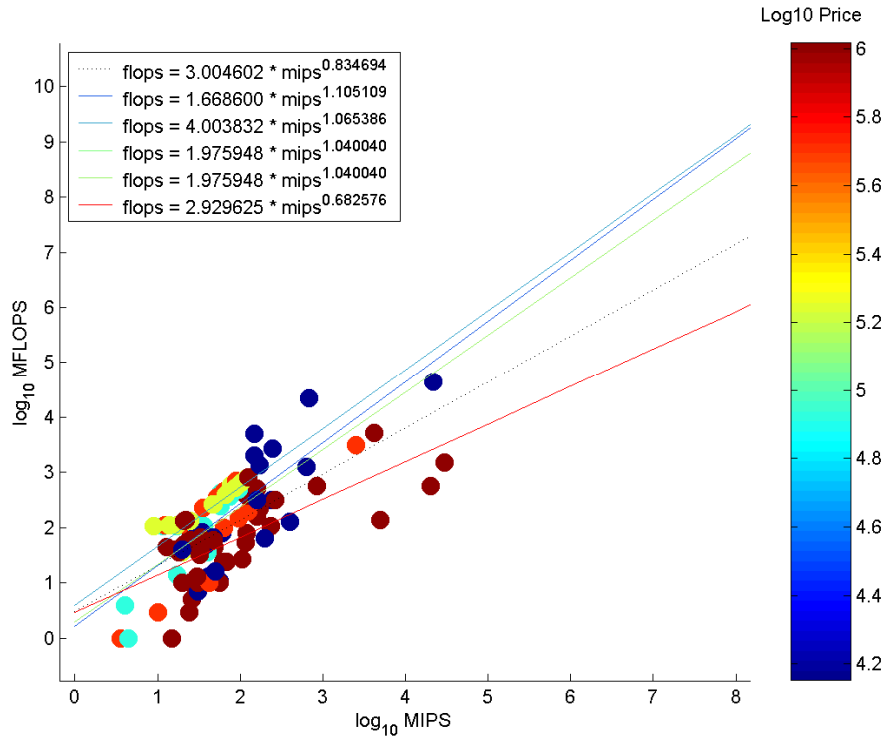
Is this exponent an artefact of early computers where numerical operations were done by one or more instructions and not representative of current computers where co-processors and other optimizations allow multiple numerical operations in the same clock cycle?



**Figure 27: Fitted conversion exponent from MIPS to FLOPS for different 5 year intervals.**

Fitting to smaller time intervals (length 5 years) from 1970 to 2000 produced a range of exponents (Figure 27). To test their reliability their values were calculated for each interval several times, each time with a different sample removed, producing a distribution (shown as grey dots) of exponents that allowed a calculation of mean and standard deviation (shown in blue). The more reliable exponents are all close to 1, with a statistically significant increase since 1986 until 1995. However, any long-term trend towards higher exponents seems hard to support.

Is the effect different in smaller computers than supercomputers? Plotting MIPS vs FLOPS, colouring the samples by their price, and then fitting exponentials produces the following graph (Figure 28).



**Figure 28: Relation between MIPS and FLOPS for different price range computers.**

This graph seems to suggest that the more expensive (and presumably more powerful) computers produce fewer FLOPS per MIPS than the cheaper ones, which have a slightly superlinear relation. However, this may be biased by the small sample of computers in the data set for which information about both FLOPS, MIPS, and price is available.

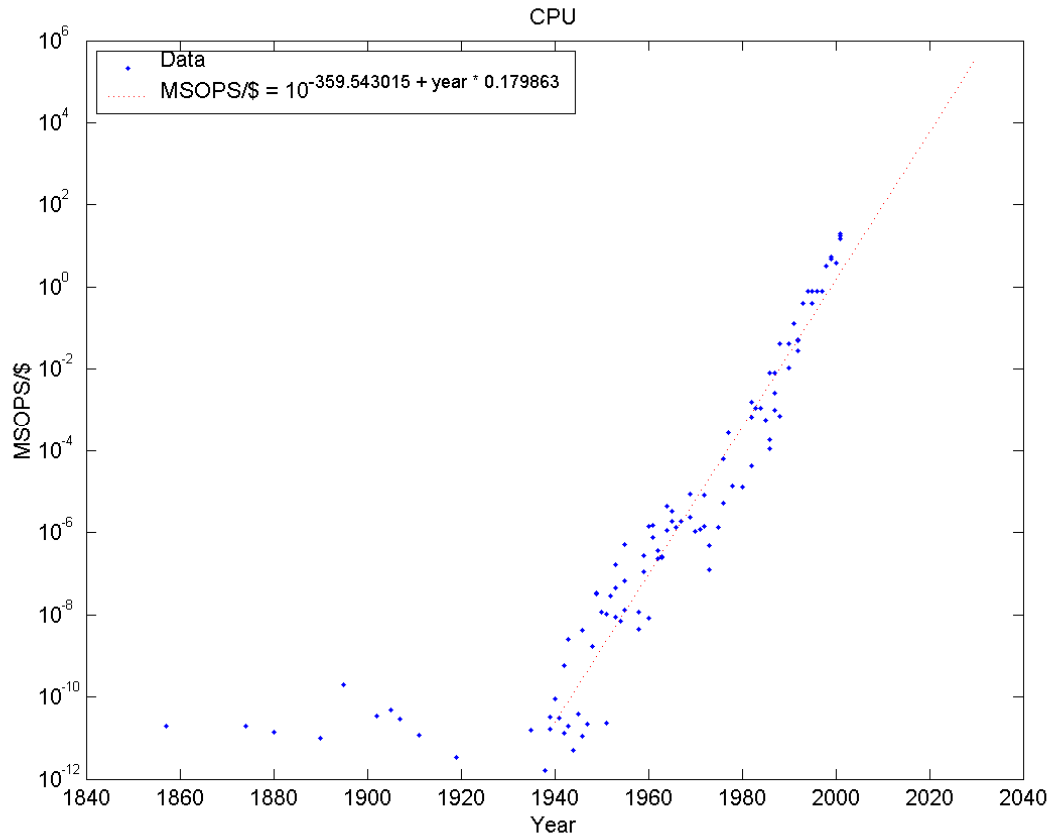
Altogether, assuming that FLOPS grow as MIPS to the power of 0.8 is probably a safe assumption, but the exponent could become  $>1$  if there were a focus on high performance calculation in processors (or other computer parts such as graphics cards). There is also a sizeable spread of proportionality constants, at least two orders of magnitude.

Putting the previous considerations together, and assuming a 1 MIPS/\$ 2007 we should expect  $F$  MFLOPS of performance achievable with a price of  $P$  dollars in  $(T/0.8) \log_{10}(F/2.3P^{0.8})$  years, assuming a decade time of  $T$ .

### Other estimates

William D. Nordhaus has done historical estimate of computer performance since the 1800's, including pre-electronic computers (Nordhaus, 2001) (partially based on data from (Morevec, 1988)). He uses millions of standardized operations per seconds (MSOPS) as his measure, 1 MSOPS roughly corresponding to 20 million 32-bit additions<sup>18</sup>. MSOPS correlates strongly with additions per second and cycles per second.

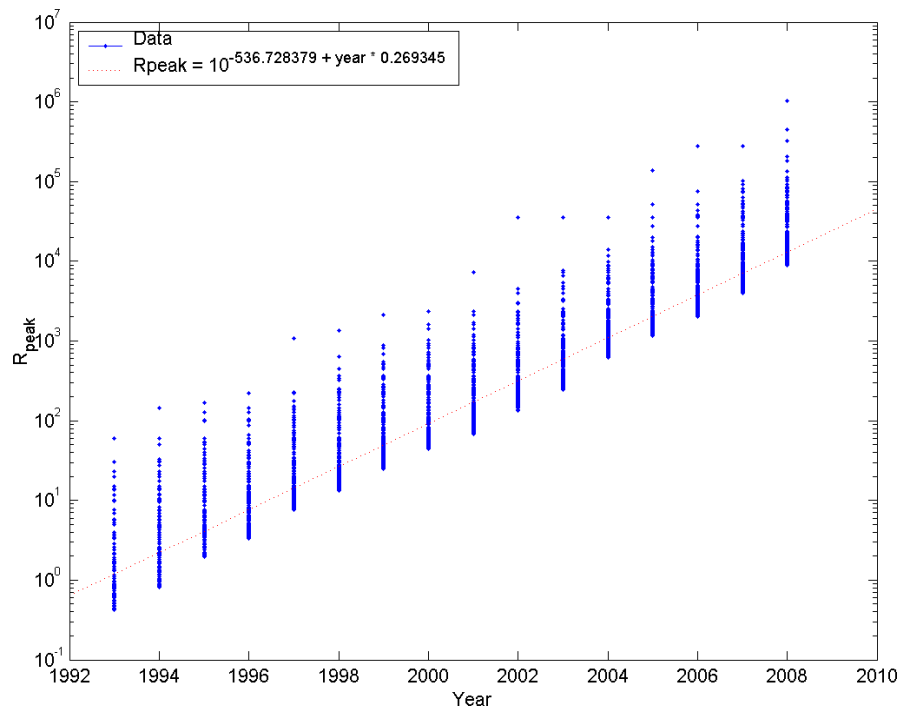
<sup>18</sup> The calculation used is  $SOPS = 0.05 ((6 + \log_2(\text{memory}) + \text{word length}) / ((7 \times \text{add time} + \text{multiplication time}) / 8))$



**Figure 29: Nordhaus data of computer performance per dollar over time.**

The data show a sharp breakpoint around 1940 when electronic computers began to develop. Before this time, performance per price was nearly stationary; afterwards it grew exponentially. The decade time is 5.6 years, agreeing with previous estimates. He also observes that supercomputer performance per price seems to lag after performance of commodity computers.

The data in (Kurzweil, 1999) tell a similar story, with decade time of 6.7 years.



**Figure 30: Peak performance of Top500 dataset of supercomputers.**

The Top500 supercomputing list<sup>19</sup> tabulates the 500 most powerful supercomputers in the world. Over 1993-2003 these machines had a doubling time for the Linpack test of 13.5 months (Feitelson, 2005), giving a decade time of just 3.82 years. Using the full dataset 1993-2008 gives a slightly shorter decade time, 3.7 years (this occurs both when using the general Linpack performance or the peak performance). A likely reason for the faster growth rate than single processor systems is that the number of processors per computer is also increasing exponentially. While the data does not include price information, the at present (June 2008) top system achieves 1 petaflops performance for ≈\$100 million, achieving 10 megaflops/\$. This appears to break previous trend predictions, suggesting that extreme high-performance systems may actually be improving much faster than the smaller systems. However, as smaller systems begin to use parallel computation the same rapid expansion may occur there too.

<sup>19</sup> [www.top500.org](http://www.top500.org)

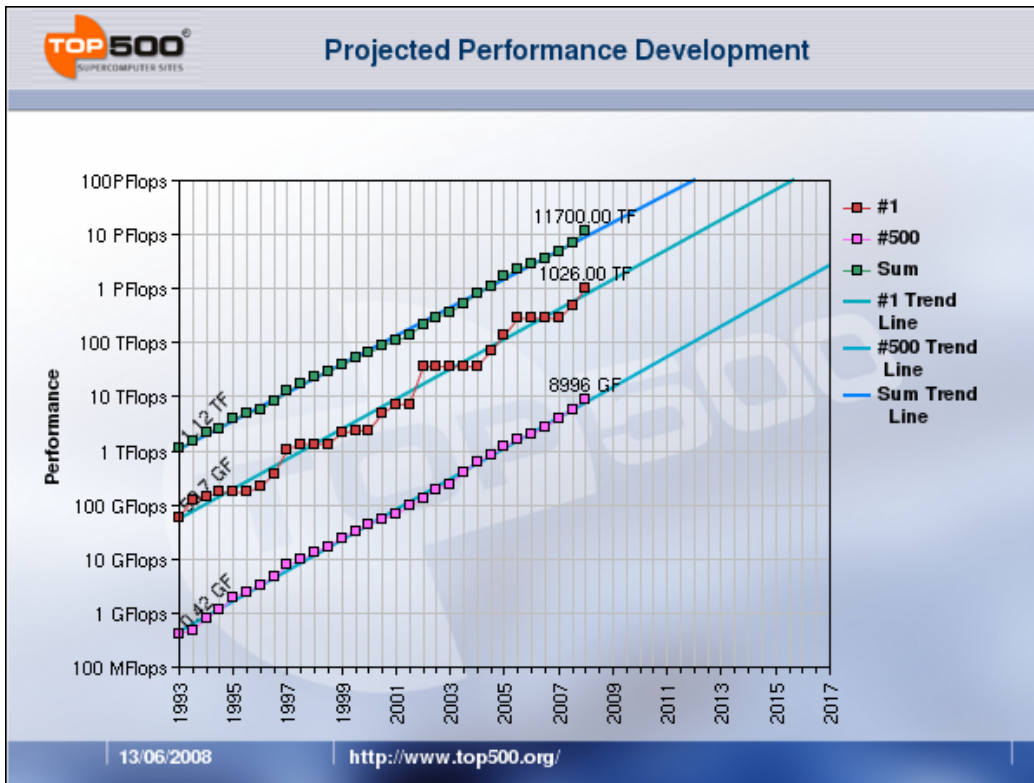


Figure 31: Projected supercomputer performance from [www.top500.org](http://www.top500.org).

### Estimating available computing power for WBE

There are three ways of estimating the computing power available for doing WBE. The first is to extrapolate the performance to price ratio of commodity computers, the second is to use top supercomputer performance directly, the third is to estimate the performance to price ratio for supercomputers. All three have merits and problems.

Commodity computers represent a lower bound: they are not very parallel so far and the economic forces driving them are not all aiming for maximum performance or even performance per dollar. We have data stretching back longer for them than for high performance computers. Using the above data produces the formula

$$[\text{MFLOPS}/\$] = 2.33 \cdot 10^{0.88(t-2007)/D}$$

where  $t$  is the year and  $D$  is the decade time of MIPS, 5.6 years (between 3.5 and 8.7 years with 95% confidence).

Absolute supercomputer performance followed a very regular exponential growth between 1993 and 2006, and has enabled reliable short-term predictions (Strohmaier and Meuer, 2004). The growth is faster than for commodity computers due to rapidly increasing parallelisation. However, there is reason to believe this parallelisation growth may conflict with the requirements of energy, cooling and space in the near future (see below). Since a WBE project is likely to be a major research undertaking, having a top 500 supercomputer available is very likely (several of the current top supercomputers have been used for computational neuroscience); the full cost of the computer may be shared between the WBE project and other projects.

Assuming a computer on par with the #500 computer, the available power grows as

$$[\text{FLOPS}] = 8.996 \cdot 10^6 \cdot 10^{(t-2008)/D}$$

Where D is 3.92. Up to two orders of magnitude more computer power is available by using more powerful computers. The cost of the computer itself would be on the order of \$10 million.

Estimating supercomputer performance/price ratios is harder since their prices are not generally listed. Using the Roadrunner computer to calibrate (~\$100 million) would give a current conversion factor of 1.026 petaflops / \$100 million, increasing with a decade time of 3.7 years. The range of ratios at each time also likely spans at least an order of magnitude: the "personal supercomputer" Microwulf's price/performance ratio (2007) was \$48/Gflop<sup>20</sup> while the Sun's Sparc Enterprise M9000 mainframe (base price of \$511,385) produced 1.03 TFLOPS of measured performance, making its PPR > \$496/Gflop. Similarly custom-built hardware can likely improve the ratio by at least 1-2 orders of magnitude (Wehner, Oliner et al., 2008). Using this we get an estimate of

$$[\text{MFLOPS}/\$] = 10.26 \cdot 10^{(t-2008)/D}$$

Where D=3.7 years and the uncertainty is at least one order of magnitude at any point in time.

## Memory

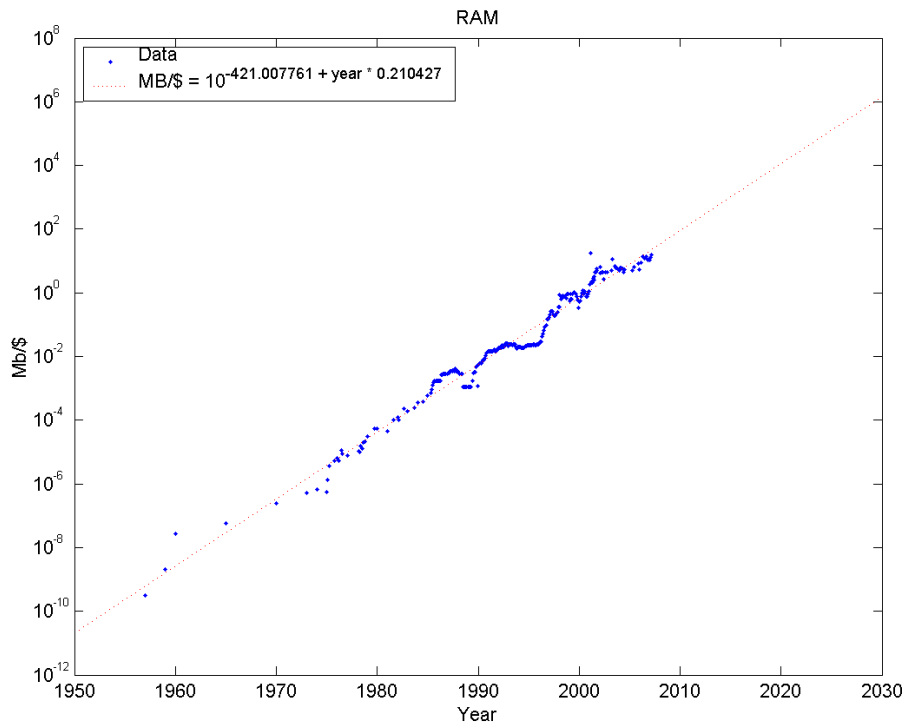
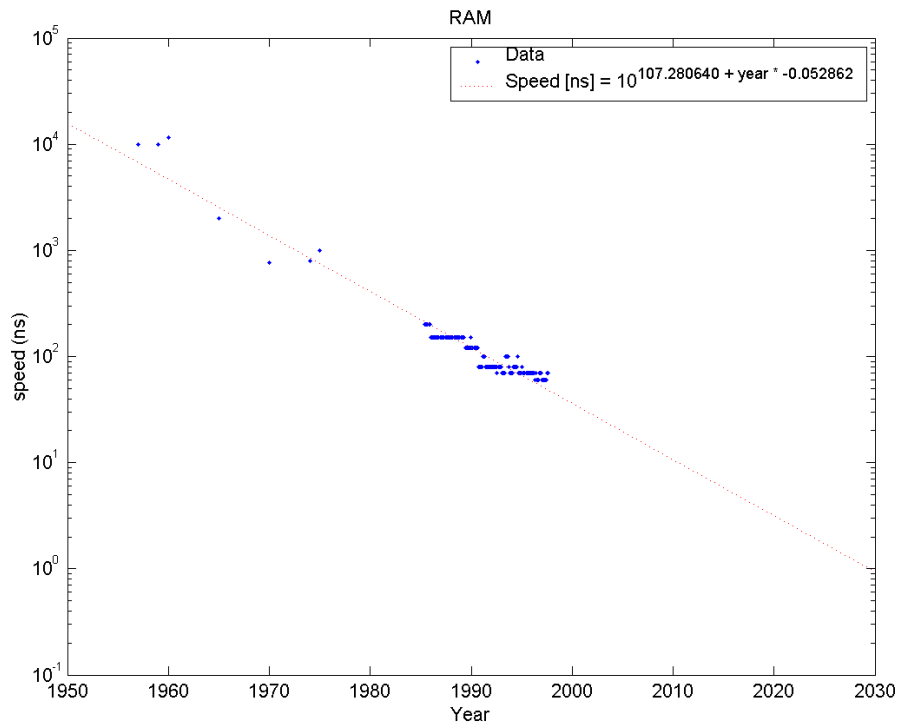


Figure 32: RAM memory per dollar over time.

<sup>20</sup> <http://www.calvin.edu/~adams/research/microwulf/>

The amount of RAM memory per dollar grows neatly exponentially, with a decade time of 4.8 years.

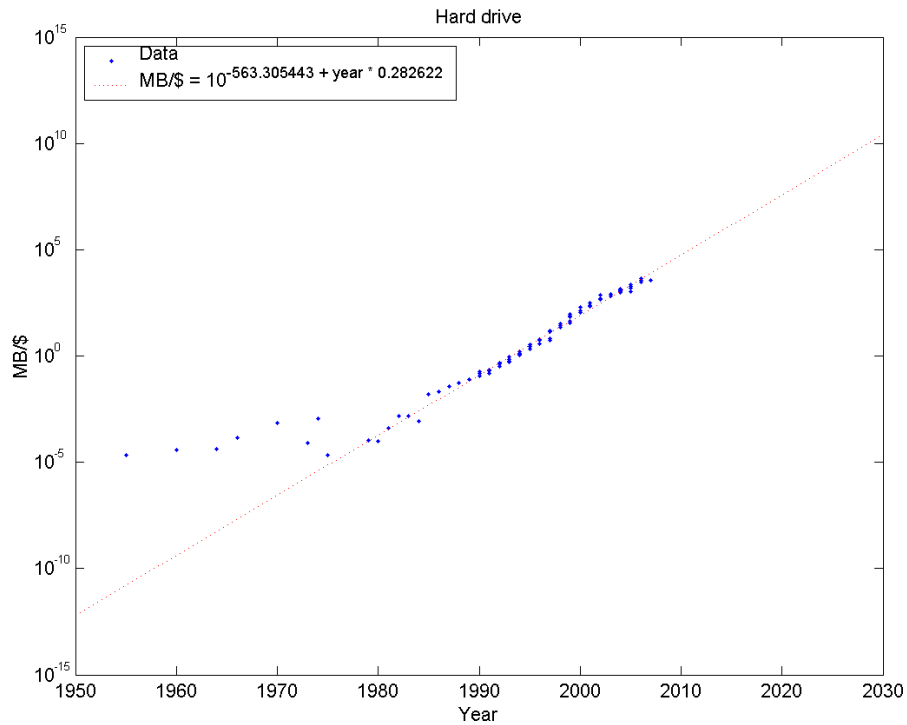


**Figure 33: RAM access speed over time.**

The access times of RAM decline in the data, although numbers are only available from the late 80's and onwards. The curve fit produces a decade time of 18.9 years.



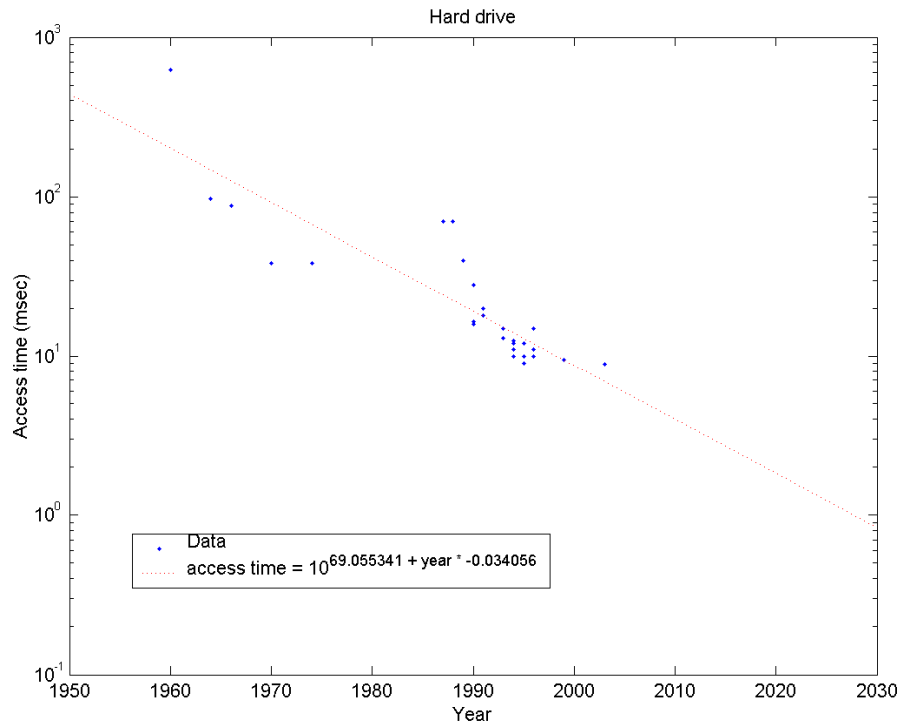
## Disc drives



**Figure 34: Disc storage per dollar over time.**

A similar trend to the exponential price-performance growth “Moore’s law” in computers is “Kryder’s law” in disc drives (Walter, 2005). The amount of storage per dollar began to grow faster around 1980 (a curve was fitted for 1980-2005), with a decade time of only 3.5 years (Figure 34). Relatively few disk access times are available, but fitting an overall exponential trend gives a decade time of 29.3 years (Figure 35).

Given the growing ratio between storage capacity and speed of both RAM and drives, updating all of the stored data will take longer and longer: storage capacity is outrunning the access speed. This may force finer granularity on brain emulations so that there are more processors with their own memory rather than few very powerful processors being limited by the amount of data they can request.



**Figure 35: Disc access time over time.**

## Future

The issue is not whether there exist physical systems able to perform the computations done by brains, since such systems already exist: the brains themselves. Rather, the issue is whether brain-emulating hardware can be constructed by human ingenuity in the foreseeable future at a sufficiently low cost to make WBE feasible.

While Moore’s law and other “exponential” progress laws in computing have held relatively steady over decades, they will presumably break at some point. At the very limit, the quantized nature of the universe is likely to limit them. Before that point, limitations on molecular building materials, light speed, and energy dissipation will prove increasingly problematic.

Semiconductors still have a long way to go (Meindl, Chen et al., 2001). The international semiconductor roadmap (ITRS07, 2007) appears relatively confident within the 2016 time horizon, and lists the research challenges needed to continue the trend towards 2022. However, this is still relatively close compared to the timescales likely for achieving WBE. Worse, improved individual chip performance may not necessarily carry over directly into improved supercomputer performance.

(DeBenedictis, 2004), a study of the limits of current technology trends found that the main problem in the not too distant future (beyond 10-20 years) is going to be heat dissipation, at least for massively parallel computers<sup>21</sup>. The expected performance in this “end game”

<sup>21</sup> The exception may be architectures dominated by memory rather than processing, which can remain dense and cool to a greater extent. WBE applications, however, are likely to need to update most of the state variables each

beyond 2016 would be in the exaflops to zettaflops range ( $10^{18}$ - $10^{21}$ ). While cooling can be made more effective by dispersing the computation units this introduces communications delays. Reversible logic may reduce heat dissipation but the best current implementations still dissipate two orders of magnitude more energy than the theoretical minimum. The study argues that a cost effectiveness of 5-8 TFLOPS/\$ and year (given running costs and pro-rated purchase price) is achievable. More efficient cooling, or less dissipative components are recognized as important for zettaflops computing (DeBenedictis, Kogge et al., 2006).

Exactly what could supersede semiconductors remains conjectural but under intense research (Welser, Bourianoff et al., 2008; Compañó, Molenkamp et al., 1999). A few of the possibilities that are being pursued or considered are:

- **Y-branch switches** are nanoelectronic components that use electrons moving in the ballistic regime that are not stopped by barriers (Forsberg and Hieke, 2002). Such devices could be used to build reversible logic gates, reducing energy dissipation (Forsberg, 2004).
- **Rapid Single Flux Quantum (RSFQ) Logic** uses superconducting quantum effects to switch, using the flux quantum as a bit (Likharev and Semenov, 1991). It can switch extremely fast (hundreds of gigahertz), has a low power consumption and existing chip technology can be adapted to make RSFQ circuitry (Zinoviev, 1997). Simple microprocessors have been demonstrated (Yoshikawa, Matsuzaki et al., 2002). However, RSFQ requires low temperatures for superconductivity.
- **Optical computing.** Using photons rather than electrons would increase transmission speeds if suitable nonlinear components can be found. The field has been pursued on and off since the 1960s with a variety of technologies (Sawchuk and Strand, 1984; Higgins, 1995). All-optical gates are approaching the performance of their electronic counterparts but still need further development (Zhang, Wang et al., 2005). A key problem is that optical communication tends to require more power over short distances than electronics, due to the need to avoid shot noise.
- **Quantum dot cellular automata (QCA).** Electron configurations in patterns of quantum dots act as a cellular automaton (Tougaw and Lent, 1994; Li, Wu et al., 2003; Robledo, Elzerman et al., 2008; Amlani, Orlov et al., 1999). Since QCA do not transmit currents and perform reversible computation (Timler and Lent, 2003) heat dissipation is low, and may provide an ideal environment for zettaflops computing (DeBenedictis, 2005). While current dots are semiconductors smaller and more temperature resistant systems could be constructed out of molecular quantum dots (Lieberman, Chellamma et al., 2002). A related technology is “spintronics”, where magnetic polarisation is used for computing (Allwood, Xiong et al., 2005; Imre, Csaba et al., 2006). While also dissipating little heat, speed limitations may make it unsuitable for rapid processing.
- **Helical logic**, reversible logic using electrons constrained to helical pathways shifted by an external field (Merkle and Drexler, 1996). While reversible it requires low temperatures to function and has speed limitations.
- **Molecular electronics**, where traditional electronics such as diodes or transistors are reproduced on the molecular level (Tseng and Ellenbogen, 2001). Logic circuits (Bachtold, Hadley et al., 2001) and non-volatile memory (Rueckes, Kim et al., 2000) based on carbon nanotube transistors have been demonstrated.
- **Intramolecular nanoelectronics**, where switching occurs on the molecule level. This would in principle be able to reach the ultimate bit densities of  $10^{12}$  bits/cm<sup>2</sup>,

---

timestep, which means they are unlikely to be storage-dominated.

switching cycles of 10 ps and 1 eV energy per bit cycle (Compañó, Molenkamp et al., 1999). It would either require high-precision self-assembly or assembly through molecular nanotechnology.

- **Rod logic**, computing using nanoscale rigid “rods” interacting mechanically, was originally suggested mostly as a proof-of-concept that computing could be done on the nanoscale (Drexler, 1992). Variants of rod logic can implement reversible computation (Merkle, 1993), making it suitable for very high density processing. It would also require molecular nanotechnology for construction.

Pessimistic claims are often made to the effect that limitations of current technology are forever unsurpassable, or that theoretically possible technological systems such as the above will be too costly and practically difficult to ever become feasible. Still, given that computer technology has developed in a relatively stable manner despite several changes of basic principles (e.g. from flip-flops via core memory to several semiconductor generations, from vacuum tubes to transistors to integrated circuits etc) there is no strong reason to assume they will break because current technology will eventually be replaced by other technologies. Large vested interests in continuing the growth are willing to spend considerable resources on closing technology gaps. A more likely end of growth scenario is that the feedback producing exponential growth is weakened by changes in the marketplace such as lowered demand, lowered expectations, rising production facility costs, long development times or perhaps more efficient software<sup>22</sup>.

If further miniaturization proves hard to achieve for one reason or another, increased performance can still be achieved by using parallelism. If many units are sold, prices will go down even if the processors are not more powerful, and a slower exponential growth of MIPS per dollar will continue. It should be noted that, since the commodity market has driven development of computers very strongly, and at present only about 15% of humanity owns a computer, there are still large untapped markets that will over time become rich enough to afford computers and hence drive further technological development. As demonstrated by various ingenious uses of GPU chip programming for high performance scientific applications, it is entirely possible to profit from a completely unrelated consumer demand if the software is adapted to high-performance hardware even when this hardware was developed for a completely different purpose (in this case computer games). The main concern for WBE is that it is entirely possible for consumer computing to go in a direction less suitable for emulation software (e.g. trading processing power for lower power usage).

---

<sup>22</sup> As an example, the exponential growth of computing power hides software bloat, where new software tends to require increasingly more resources to do the same tasks as old versions. This is partially due to trading program efficiency for programming simplicity. The expectation of exponentially growing hardware capabilities makes it worthwhile to get new hardware often, which together with the bloat feeds the cycle. If hardware development were to slow incentives to avoid bloat would emerge, and even for non-bloating software applications the benefits of buying new hardware often would lessen. This would reduce the strength of the feedback loop (and possibly remove it), severely reducing the increase in computing capabilities.

## Appendix C: Large-scale neural network simulations

These simulations represent a small sampling of the literature. There is a bias towards research aimed at high performance computational neuroscience and developing new methods.

**Table 11: Large-scale neural simulations**

Simulation	Type of simulation	Neurons	Synapses	Hardware and Software	Slowdown (time required for 1 biological second)	Timestep	Notes
(Plesser, Eppler et al., 2007)	Integrate-and-fire	12,500	$1.56 \cdot 10^7$	Sun X4100 cluster, 2.4Ghz AMD Opteron, 8GB ram, MPI, NEST	2	0.1 ms	Supralinear scaling until 80 virtual processes for $10^5$ neuron/ $10^9$ synapses.
(Djurfeldt, Lundqvist et al., 2006)	6-compartment neurons	$2.2 \cdot 10^7$	$1.1 \cdot 10^{10}$	IBM Watson Research Blue Gene, SPLIT	5,942		Computing requirements: 11.5 TFLOPS. Spatial delays corresponding 16 cm <sup>2</sup> cortex surface.
(Izhikevich, 2005)	Izhikevich neurons, Random synaptic connectivity generated on the fly.	$10^{11}$	$10^{15}$	Beowulf cluster, 27 3GHz processors	$4.2 \cdot 10^6$		
(Howell, Dyhrfeld-Johnsen et al., 2000)	Compartment (Purkinje 4,500 comp./granule 1 comp.)	16 Purkinje, 244,000 granule cells		128-processor Cray 3TE, PGENESIS	4,500		Computing requirements: 76.8 GFLOPS
(Howell, Dyhrfeld-Johnsen et al., 2000)		60,000 granule cells, 300 mossy fibers, 300 Golgi cells, 300 stellate cells, 1 Purkinje cell		Single workstation 1GB memory, GENESIS	79,200	20 $\mu$ s	
(Kozlov, Lansner et al., 2007)	5 compartment model	900	10% per hemisegment	SPLIT		100 $\mu$ s	
(Frye, Ananthanarayanan et al., 2007)	Low complexity spiking like Izhikevich neurons, STDP synapses	$8 \cdot 10^6$	$6300 \cdot 8 \cdot 10^6 = 5.04 \cdot 10^{10}$	4096 processor BlueGene/L 256 Mb per CPU	10	1 ms	
(Brette, Rudolph et al., 2007; Traub, Contreras et al., 2005)	14 cell types, conductance and compartment model	3,560	3,500 gap junctions, 1,122,520 synapses	Cray XT3 2.4 Ghz, 800 CPUs	200?	Event driven	5954-8516 equations/CPU Gives # compartments
(Traub, Contreras et al., 2005)	14 cell types, conductance and compartment model, 11 active conductances	3,560	3,500 gap junctions, 1,122,520 synapses	14 cpu Linux cluster, an IBM e1350, dual-processor Intel P4 Xeon		2 $\mu$ s	

(Goodman, Courtenay Wilson et al., 2001)	3 layer cortical column, 25% GABAergic, conductance models, synapse reversal pot., conductance, abs. str., mean prob. release, time const. recover depress facilitation,	5,150 per node, max 20*5,150=103,000	In columns 192,585 per node, max 20 = 3.85·10 <sup>6</sup> , intercolumn 1.4·10 <sup>6</sup>	2.4-GHz, 512 Kbytes of L2 cache; or, e1350 Blade 1, at 2.8 GHz NCS, 30 dual-Pentium III 1GHz processor nodes, with 4 GB of RAM per node	165,000	
(Frye, 2004)	Four cell types. K <sub>m</sub> , K <sub>a</sub> , K <sub>ahp</sub> channels	1,000/cells column, 2,501 columns = 2.5·10 <sup>6</sup>	250K per column, total 6.763·10 <sup>8</sup>	BlueGene, 1024 CPUs	3,000?	2.338·10 <sup>10</sup> spikes per processor. Memory requirement 110 Mb per processor
(Aberdeen, Baxter et al., 2000)	ANN feedforward network trained with iterative gradient descent	4,083	1.73·10 <sup>6</sup>	Cluster 196 pentium III processors, 550 MHz, 384Mb		
(Kondo, Koshiba et al., 1996)	Hopfield network	1,536	2.4·10 <sup>6</sup>	Special purpose chips		
(Cortex, 2003)	Layered distribution of neural nets, detailed synaptic interconnections, spiking dynamics	2·10 <sup>10</sup>	2·10 <sup>13</sup>	500 nodes, 1,000 processors, 1 Tb RAM. Theoretical peak of 4,800 Gflops.		Claimed performance, not documented.
(Harris, Baurick et al., 2002)	Point neurons, spikes, AHP, A & M potassium channels, synaptic adaptation, Spike shape and postsynaptic conductance specified by templates.	35,000 cells per node	6.1·10 <sup>6</sup> synapses per node	Cluster, 128 Xeon 2.2 GHz processors with 256GB, 1Tb disk		
(Mehrtash, Jung et al., 2003)	Integrate and fire, event driven pulse connections with STDP plasticity. 1-8 dendritic segments.	256,000	10 <sup>6</sup>	Special purpose chip, connected UltraSparc processor 500 Mhz, 640 Mb	1012.21 timessteps/ms	
(Shaojuan and Hammarstrom, 2002)	Palm binary network	256,000	Order of 3.2·10 <sup>10</sup>	512 processors, 192 GB, 250 Mhz mips 12K processor	Execution time 4 min 7 sec, -13% MPI calls for retrieving 180K training vectors, ~O(10) iterations	
(Johansson and Lansner, 2007)	BCPNN spiking, minicolumns hypercolumns	1.6·10 <sup>6</sup>	2.0·10 <sup>11</sup>	256 node, 512 processors, Dell Xeon cluster,	9% real-time = 11.1	Weight updates 47 ms, update activities 59 ms

(Markram, 2006)	Morphologically complex compartment models	10,000	$10^8$	3.4GHz 8 Gb memory, peak performance 13.6 Gflop				120 kW usage. Computational demand 256*13.6 Gflops
(Traub and Wong, 1982)		100						
(Traub, Miles et al., 1992)	19 compartment cells, ionic currents	1,200	70,000	IBM3090 computer	325 min/1.5 s	0.05 ms		
(Moll and Miikkulainen, 1997)	Binary units with binary weights	79,500	$7.82 \cdot 10^8$	Cray Y-MP 8/864	0.006 s (retrieval of 550,000 patterns; assuming human retrieval speed = 1 s)	-		

Plotting the size of the simulations over time does suggest a rapidly increasing scale, although there is not enough data to estimate a reliable trend. There does not seem to exist a clear separation between biologically detailed models and highly simplified models; some of the largest simulations have been detailed compartment models.

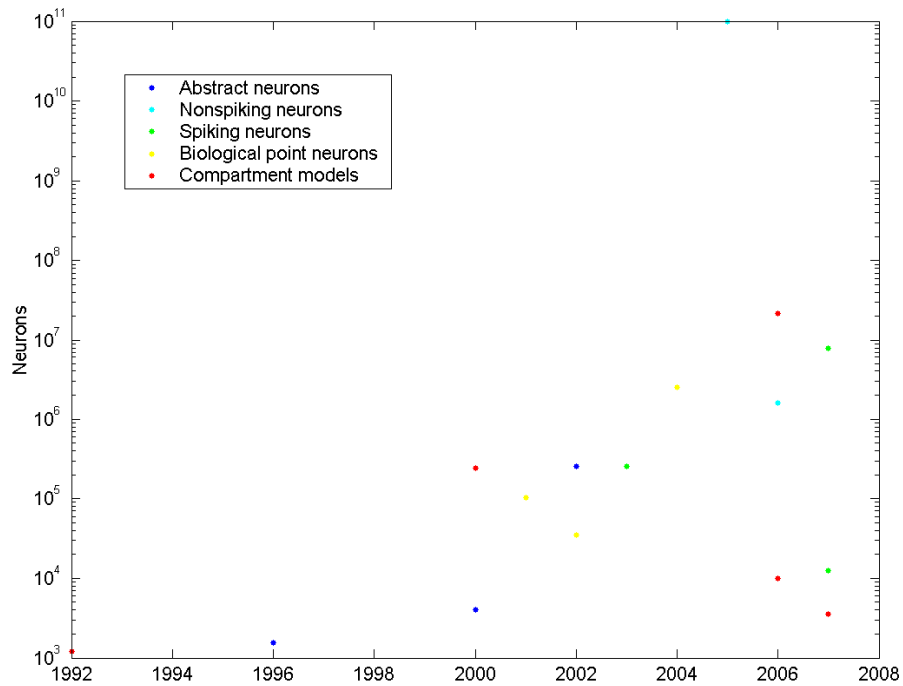
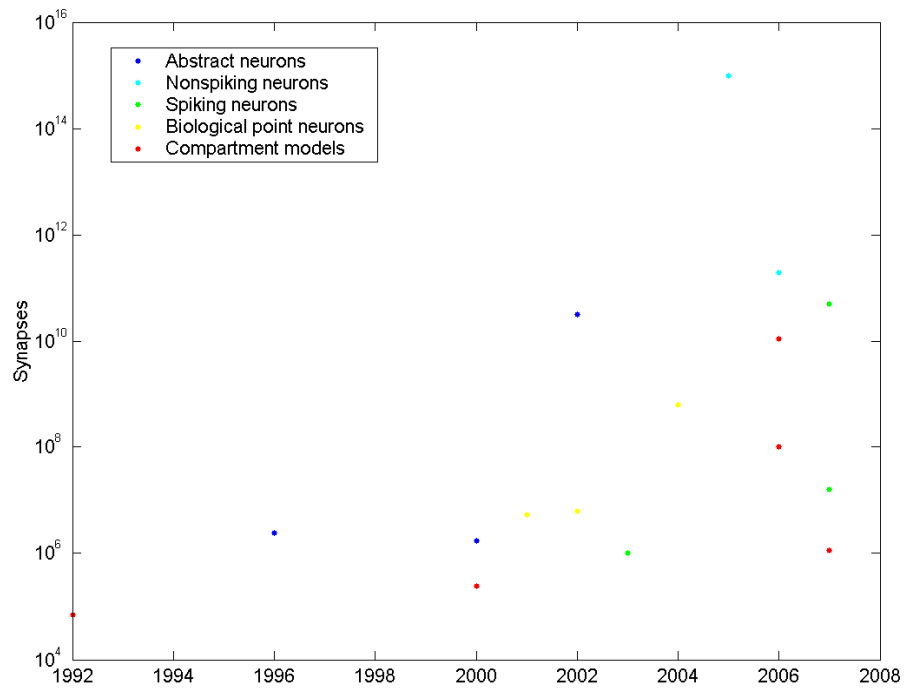


Figure 36: Number of neurons in different large computational neuroscience models.



**Figure 37: Number of synapses in different computational neuroscience models.**



## Appendix D: History and previous work

The earliest origins of the mind emulation idea can perhaps be traced back to J.D. Bernal's *The World, The Flesh, The Devil* (1929), where he wrote:

“Men will not be content to manufacture life: they will want to improve on it. For one material out of which nature has been forced to make life, man will have a thousand; living and organized material will be as much at the call of the mechanized or compound man as metals are to-day, and gradually this living material will come to substitute more and more for such inferior functions of the brain as memory, reflex actions, etc., in the compound man himself; for bodies at this time would be left far behind. The brain itself would become more and more separated into different groups of cells or individual cells with complicated connections, and probably occupying considerable space. This would mean loss of motility which would not be a disadvantage owing to the extension of the sense faculties. Every part would not be accessible for replacing or repairing and this would in itself ensure a practical eternity of existence, for even the replacement of a previously organic brain-cell by a synthetic apparatus would not destroy the continuity of consciousness.

...

Finally, consciousness itself may end or vanish in a humanity that has become completely etherialized, losing the close-knit organism, becoming masses of atoms in space communicating by radiation, and ultimately perhaps resolving itself entirely into light.”

Bernal's vision corresponds to a gradual replacement of biology with artificial parts, gradually making it unnecessary to keep the brain in one location.

In the science fiction novel *City and the Stars* (1956) Arthur C. Clarke described a far future city where bodies are manufactured by the central computer, minds stored in its databanks downloaded into them, and when an inhabitant dies their mind is stored yet again in the computer, allowing countless reincarnations. Other early science fiction treatments were Roger Zelazky's *Lord of Light* (1968), Bertil Mårtensson's *Detta är verkligheten* (1968) and Rudy Rucker's *Software* (1979). Since then, mind emulation (“uploading”) has become a staple of much science fiction<sup>23</sup>. Of particular note in terms of technological and philosophical details are the novels and short stories by Greg Egan (*Permutation City*, *Diaspora*, *Learning to be Me*, *Transition Dreams* etc).

Brain (and mind) emulation has also been widely discussed in philosophy of mind, although more as *Gedankenexperimente* than possible actual practice (e.g. (Parfit, 1984; Chalmers, 1995; Searle, 1980)).

The first attempt at a careful analysis of brain emulation was a technical report (Merkle, 1989b) predicting that “a complete analysis of the cellular connectivity of a structure as large as the human brain is only a few decades away”. The report reviewed automated analysis and reconstruction methods, going into great detail on the requirements needed for parallel processing of brain samples using electron microscopes and image analysis software. It also clearly listed assumptions and requirements, a good example of falsifiable design.

---

<sup>23</sup> E.g. [http://en.wikipedia.org/wiki/Mind\\_transfer\\_in\\_fiction](http://en.wikipedia.org/wiki/Mind_transfer_in_fiction)

The first popularization of a technical description of a possible mind emulation scenario was found in Hans Moravec's *Mind Children* (1990), where the author describes the gradual neuron-by-neuron replacement of a (conscious) brain with software. Other forms of emulation are also discussed.

(Hanson, 1994) was the first look at the economical impact of copyable minds, showing that social role-fit brain emulation would likely cause dramatic economic and demographic changes .

One sketch of a person emulation scenario (Leitl, 1995) starts out by the cryonic suspension of the brain, which is then divided into cubic blocks  $< 1\text{mm}$ . The blocks can individually be thawed for immunostaining or other contrast enhancement. For scanning, various methods are proposed: X-ray fresnel/holographic diffraction, X-ray or neutron beam tomography (all risking radiation damage, might require strong staining), transmission EM (requires very thin samples), UV-abrasion of immunostained tissue with mass spectrometry, or abrasive atomic force microscope scan. While detailed in terms of the cryosuspension methods, the sketch becomes less detailed in terms of actual scanning method and implementing the emulation.

# *Appendix E: Non-destructive and gradual replacement*

## **Non-Destructive Scanning**

Non-destructive scanning requires minimally invasive methods. The scanning needs to acquire the relevant information at the necessary 3D resolution. There are however several serious limitations:

- The movement of biological tissue, requiring either imaging faster than it can move or accurate tracking. In cats, the arterial pulse produces 110–266  $\mu\text{m}$  movements lasting 330–400 ms and breathing larger (300–950  $\mu\text{m}$ ) movements (Britt and Rossi, 1982)<sup>24</sup>. The stability time is as short as 5–20 ms.
- Imaging has to occur over a distance of >150 mm (the width of an intact brain) or be invasive.
- The imaging must not deposit enough energy (or use dyes, tracers or contrast enhancers) to hurt the organism.
- The method must not significantly alter the mental or neural state of the subject being scanned in order to avoid a possibly significant “observer effect” anomalies and false reading that could produce a flawed emulation model.

Of the possible non-invasive candidates only MRI appears able to fulfil the limitations even in principle. Optic imaging, even using first-arriving light methods, would not work across such a large distance. X-ray tomography of the intensity needed to image tissue would deposit harmful energy (see discussion on X-ray microscopy).

The resolution of MRI depends on the number of phase steps used, gradient strength, acquisition time and desired signal-to-noise ratio. To record micron-scale features in a moving brain, very short acquisition times are needed, or a way of removing the movement artefacts. Each doubling of spatial resolution divides the signal-to-noise ratio by 8, requiring longer acquisition times, stronger fields or more sensitive detectors. Finally, there are also problems with tissue water self-diffusion, making resolutions smaller than 7.7  $\mu\text{m}$  impossible to achieve (Glover and Mansfield, 2002)<sup>25</sup>. Given that brain emulation on the synaptic level requires higher resolution, this probably rules out MRI as a non-destructive scanning method.

However, if the brain is frozen, water diffusion and movement do not occur and very long acquisition times can be used. One problem with MRI of frozen brain tissue is that limited proton mobility reduces the signal; this can be ameliorated by keeping the brain at  $-1^{\circ}\text{C}$  (Longson, Hutchinson et al., 1995; Doyle, Longson et al., 1996). MRI might therefore be a possible scanning method for frozen or fixed brains. Since it is not destructive to the tissue it may also act as an adjunct to other, destructive, scanning methods.

---

<sup>24</sup> The authors of the paper suggests as a solution using a cardiac bypass system to create a nonpulsative flow of oxygenated blood.

<sup>25</sup> Higher resolutions have been reported based on using micro-coil receivers and very strong magnetic field gradients. (Ciobanu, Seeber et al., 2002) reports a resolution of  $3.7 \times 3.3 \times 3.3 \mu\text{m}$ , but the imaging time was 30h and the authors were pessimistic about the ability to detect different chemicals.

A possible way around the problems of non-invasive scanning would be to use endoscopic methods to bring measurement devices into the blood vessels of the brain and image it from inside. Endoscopic MRI has been demonstrated in the gastrointestinal system where a RF coil was affixed to the tip of an endoscope (Inui, Nakazawa et al., 1998). This is limited by the range of the devices, their size and the risks of penetrating vessels. However, it appears unlikely that all parts of the brain are close enough to a large blood vessel to allow accurate scanning, even leaving out the resolution and movement issues.

Correlation mapping using nanoprobes (Strout, 2006) has also been suggested. A large number ( $10^{12}$ ) of nanomachines set up residence in or on neurons, recording their activity and functional correlations. A more detailed analysis of how nanomachines could sense neural activity can be found in (Freitas Jr, 1999, section 4.8.6) together with a sketch of an in vivo fibre network with  $10^{18}$  bit/s capacity (Freitas Jr, 1999, section 7.3.1). This would enable essentially real-time monitoring of all neurons and their chemical environment (Kurzweil, 2005, pp. 548-549). Whether just the activity would be enough to map the connectivity and memory states of the brain is unclear. However, given the assumed technology both intracellular probing and physical connectivity mapping by histonating nanorobots appears possible. Whether this would interfere with brain function is hard to estimate (but see (Freitas Jr., 2003) for an analysis). The fibre network would have a volume of  $30 \text{ cm}^3$ , which is  $\approx 41\%$  of the normal blood volume in the brain (based on estimates of blood volume in (Leenders, Perani et al., 1990)), possibly impeding bloodflow if extended inside vessels. Although the capabilities of nanomachines can be constrained by known physics it is not possible today to infer enough about machine/cell/tissue interactions to estimate whether non-destructive scanning is feasible.

Overall, the prospects for non-destructive scanning do not look good at present. At the very least it would need to involve very invasive endoscopic scanning or the use of advanced nanomedicine.

## Gradual replacement

Scanning might also occur in the form of gradual replacement, as piece after piece of the brain is replaced by an artificial neural system interfacing with the brain and maintaining the same functional interactions as the lost pieces. Eventually only the artificial system remains, and the information stored can be moved if desired (Morevec, 1988). While gradual replacement might assuage fears of loss of consciousness and identity<sup>26</sup> it appears technically very complex as the scanning system not only has to scan a living, changing organism but also interface seamlessly with it (at least on the submicron scale) while working. The technology needed to achieve it could definitely be used for scanning by disassembly. Gradual replacement is therefore not likely as a first form of brain emulation scanning (though in practice it may eventually become the preferred method if non-destructive scanning is not possible).

It is sometimes suggested that extending the brain through interfaces with external software might achieve a form of transfer where more and more of the entire person is stored outside the brain, possibly reaching the point where the brain is no longer essential for the composite person. However, this would not be brain emulation per se but rather a transition to a

---

<sup>26</sup> But not necessarily. Searle has argued that replacement would gradually remove conscious experience (Searle, 1980). Parfit's 'physical spectrum' thought experiment involves interpolating between two different people that clearly have different identities, and the replacement process could have a similar property (Parfit, 1984).

posthuman state. The technical feasibility appears ill-defined given current knowledge. It should be noted that even relatively partial such interfaces or life recording (Gemmell, Bell et al., 2006) would produce a wealth of useful data for developing brain emulations by acting as a yardstick of normal function<sup>27</sup>.

---

<sup>27</sup> Again, it is sometimes suggested that recording enough of the sensory experiences and actions would be enough to produce brain emulation. This is unlikely to work simply because of the discrepancy in the number of degrees of freedom between the brain (at least  $10^{14}$  synaptic strengths distributed in a  $10^{22}$  element connectivity matrix) and the number of bits recorded across a lifetime (less than  $2 \cdot 10^{14}$  bits (Gemmell, Bell et al., 2006)).

## *Appendix F: Glossary*

<b>AFM</b>	Atomic force microscope (sometimes called scanning force microscope).
<b>ANN</b>	Artificial Neural Network, a mathematical model based on biological neural networks.
<b>ATLUM</b>	Automatic Tape-Collecting Lathe Ultramicrotome
<b>Autoregulation</b>	Regulation of blood flow to maintain the (cerebral) environment.
<b>Axon</b>	Projection from a nervcell that conducts signals away from the neuron's cell body.
<b>Blockface</b>	The surface of an imaged sample, especially when cutting takes place.
<b>bouton</b>	The typical synaptic bump that grows between axons and dendrites.
<b>CNS</b>	Central Nervous System.
<b>Confocal microscopy</b>	Optical imaging technique to image 3D samples by making use of a spatial pinhole.
<b>Connectome</b>	The total set of connections between regions or neurons in a brain (Sporns, Tononi et al., 2005).
<b>Dendrite</b>	Branched projections of neurons that conduct signals from other neurons to the cell body.
<b>Exaflop</b>	10 <sup>18</sup> FLOPS.
<b>Extracellular</b>	The environment outside the cells.
<b>FIBSEM</b>	Focused Ion Beam SEM.
<b>FLOPS</b>	Floating point Operations Per Second. A measure of computing speed.
<b>Fluorophore</b>	A molecule or part of molecule that causes fluorescence when irradiated by UV light. Used for staining microscope preparations.
<b>FPGA</b>	Field-Programmable Gate Array. Semiconductor device that contains programmable logic and interconnects, allowing the system designer to set up the chip for different purposes.
<b>GABAergic</b>	Related to the transmission or reception of GABA, the chief inhibitory neurotransmitter.
<b>GFLOP</b>	Gigaflop, a billion FLOPS.
<b>Glia</b>	Glia cells are non-neuronal cells that provide support, nutrition and many other functions in the nervous system.
<b>Hypercolumn</b>	A group of cortical minicolumns organised into a module with a full set of values for a given set of receptive field parameters.
<b>Interneuron</b>	In the CNS, a small locally projecting neuron (unlike neurons that project to long-range targets).
<b>Kinase</b>	An enzyme that phosphorylates other molecules.
<b>Ligand</b>	A molecule that bonds to another molecule, such as a receptor or enzyme.
<b>Metabolome</b>	The complete set of small-molecule metabolites that can be found in an organism.
<b>MFLOPS</b>	Millions of Floating point Operations Per Second. A measure of computing speed.
<b>Microtubule</b>	A component of the cell skeleton, composed of smaller subunits.

<b>Minicolumn</b>	A vertical column through the cerebral cortex; a physiological minicolumn is a collection of about 100 interconnected neurons, a functional minicolumn consists of all neurons that share the same receptive field.
<b>MIPS</b>	Millions of Instructions Per Second. A measure of computing speed.
<b>Motorneuron</b>	A neuron involved in generating muscle movement.
<b>MRI</b>	Magnetic Resonance Imaging.
<b>Neocortex</b>	The cerebral cortex, covering the cerebral hemispheres. Neocortex distinguishes it from related but somewhat more “primitive” cortex that have fewer than six layers.
<b>Neurite</b>	A projection from the cell body of a neuron, in particular from a developing neuron where it may become an axon or dendrite.
<b>Neurogenesis</b>	The process by which neurons are created from progenitor cells.
<b>Neuromodulator</b>	A substance that affects the signalling behaviour of a neuron.
<b>Neuromorphic</b>	Technology aiming at mimicking neurobiological architectures.
<b>Neuron</b>	A nerve cell.
<b>Neuropeptide</b>	A neurotransmitter that consists of a peptide (amino acid chain).
<b>Neurotransmitter</b>	A chemical that relays, amplifies or modulates signals from neurons to a target cell (such as another neuron).
<b>Parallelisation</b>	The use of multiple processors to perform large computations faster.
<b>PCR</b>	Polymerase Chain Reaction, a technique for amplifying DNA from a small sample.
<b>Petaflop</b>	$10^{15}$ FLOPS.
<b>Phosphorylation</b>	Addition of a phosphate group to a protein molecule (or other molecule), usually done by a kinase. This can activate or deactivate the molecule and plays an important role in internal cell signalling.
<b>PNS</b>	Peripheral Nervous System.
<b>Potentiation</b>	The increase in synaptic response strength seen after repeated stimulation.
<b>SBFSEM</b>	Serial Block-Face Scanning Electron Microscopy
<b>SEM</b>	Scanning Electron Microscopy.
<b>Sigmoidal</b>	S-shaped, usually denoting a mathematical function that is monotonously increasing, has two horizontal asymptotes and exactly one inflection point.
<b>Skeletonization</b>	Image processing method where a shape is reduced to the set of points equidistant from its boundaries, representing its topological structure.
<b>Soma</b>	The cell body of a neuron.
<b>Spectromicroscopy</b>	Methods of making spectrographic measures of chemical composition in microscopy.
<b>SSET</b>	Serial Section Electron Tomography
<b>SSTEM</b>	Serial Section Transmission Electron Microscopy
<b>Supervenience</b>	A set of properties A supervenes on a set of properties B if and only if any two objects x and y that share all their B properties must also share all their A properties. Being B-indiscernible implies being A-indiscernible.
<b>Synapse</b>	A junction where one (or more) neurons signal to each other.
<b>Synaptic spine</b>	Many synapses have their boutons offset from their parent

<b>TEM</b>	dendrite through a thinner filament.
<b>TFLOPS</b>	Transmission Electron Microscopy.
<b>Tortuosity</b>	Teraflops, $10^{12}$ FLOPS.
<b>V1</b>	A measure of how many turns a surface or curve make.
<b>Voxel</b>	The primary visual cortex.
	A volume element, representing a value on a regular grid in 3D space.



## References

- ABERDEEN D, BAXTER J, and EDWARDS R. 92¢ /mflops/s, ultra-large-scale neural-network training on a piii cluster. In *Supercomputing, acm/ieee 2000 conference*, 2000, pp. 44-44.
- ACHARD P and DE SCHUTTER E. Complex parameter landscape for a complex neuron model. *Plos Computational Biology*, 2: 794-804, 2006.
- ACKERMANN M and MATUS A. Activity-induced targeting of profilin and stabilization of dendritic spine morphology. *Nature Neuroscience*, 6: 1194-1200, 2003.
- AJAY SM and BHALLA US. Synaptic plasticity in vitro and in silico: Insights into an intracellular signaling maze. *Physiology*, 21: 289-296, 2006.
- AL-KOFAHI KA, LASEK S, SZAROWSKI DH, et al. Rapid automated three-dimensional tracing of neurons from confocal image stacks. *IEEE Trans Inf Technol Biomed*, 6: 171-87, 2002.
- ALLWOOD DA, XIONG G, FAULKNER CC, et al. Magnetic domain-wall logic. *Science*, 309: 1688-1692, 2005.
- AMLANI I, ORLOV AO, TOTH G, et al. Digital logic gate using quantum-dot cellular automata. *Science*, 284: 289-291, 1999.
- ANDERSON FC and PANDY MG. Dynamic optimization of human walking. *J Biomech Eng*, 123: 381-90, 2001.
- ARNOLD AS, SALINAS S, ASAKAWA DJ, and DELP SL. Accuracy of muscle moment arms estimated from mri-based musculoskeletal models of the lower extremity. *Comput Aided Surg*, 5: 108-19, 2000.
- ARRADIANCE INC. *Massively parallel e-beam sources for semiconductor lithography and metrology*. 2007 <http://arradiance.com/>.
- ASCOLI GA. Progress and perspectives in computational neuroanatomy. *Anatomical Record*, 257: 195-207, 1999.
- ATWOOD HL and WOJTOWICZ JM. Silent synapses in neural plasticity: Current evidence. *Learning & Memory*, 6: 542-571, 1999.
- BACHTOLD A, HADLEY P, NAKANISHI T, and DEKKER C. Logic circuits with carbon nanotube transistors. *Science*, 294: 1317-1320, 2001.
- BAIRD RC, JOHARI H, and GY. J. Numerical simulation of environment modulation of chemical signal structure and odor dispersal in the open ocean. *Chem Senses.*, 21: 121-134, 1996
- BARZEL R, HUGHES JF, and WOOD DN. Plausible motion simulation for computer graphics animation. In Boulic R. and Hégron G. (Eds.), *Computer animation and simulation '96*: Springer, 1996, pp. 183-197.
- BEECHER CWW. The human metabolome. In Harrigan G.G. (Ed.) *Metabolic profiling: Its role in biomarker discovery and gene function analysis*: Springer Verlag, 2003.
- BEKENSTEIN JD. Universal upper bound on the entropy-to-energy ratio for bounded systems. *Physical Review D*, 23: 287-298, 1981.
- BENHAM MP, WRIGHT DK, and BIBB R. Modelling soft tissue for kinematic analysis of multi-segment human body models. *Biomed Sci Instrum*, 37: 111-6, 2001.
- BERG RW, ALABURDA A, and HOUNSGAARD J. Balanced inhibition and excitation drive spike activity in spinal half-centers. *Science*, 315: 390-393, 2007.
- BHALLA US. Signaling in small subcellular volumes. I. Stochastic and diffusion effects on individual pathways. *Biophysical Journal*, 87: 733-744, 2004a.
- BHALLA US. Signaling in small subcellular volumes. Ii. Stochastic and diffusion effects on synaptic network properties. *Biophysical Journal*, 87: 745-753, 2004b.
- BHALLA US and IYENGAR R. Emergent properties of networks of biological signaling pathways. *Science*, 283: 381-387, 1999.

- BHARDWAJ RD, CURTIS MA, SPALDING KL, et al. Neocortical neurogenesis in humans is restricted to development. *Proceedings of the National Academy of Sciences of the United States of America*, 103: 12564-12568, 2006.
- BI GQ and POO MM. Synaptic modifications in cultured hippocampal neurons: Dependence on spike timing, synaptic strength, and postsynaptic cell type. *Journal of Neuroscience*, 18: 10464-10472, 1998.
- BIENENSTOCK EL, COOPER LN, and MUNRO PW. Theory for the development of neuron selectivity - orientation specificity and binocular interaction in visual-cortex. *Journal of Neuroscience*, 2: 32-48, 1982.
- BINZEGGER T, DOUGLAS RJ, and MARTIN KAC. A quantitative map of the circuit of cat primary visual cortex. *Journal of Neuroscience*, 24: 8441-8453, 2004.
- BIOMECHANICS RESEARCH GROUP INC. *Brg.Lifemod 2005®: Biomechanics modeling package*. 2005 <http://www.lifemodeler.com/>.
- BLATOW M, CAPUTI A, and MONYER H. Molecular diversity of neocortical gabaergic interneurons. *Journal of Physiology-London*, 562: 99-105, 2005.
- BLEMKER SS, ASAKAWA DS, GOLD GE, and DELP SL. Image-based musculoskeletal modeling: Applications, advances, and future opportunities. *J Magn Reson Imaging*, 25: 441-51, 2007.
- BLEMKER SS and DELP SL. Three-dimensional representation of complex muscle architectures and geometries. *Ann Biomed Eng*, 33: 661-73, 2005.
- BOKIL H, LAARIS N, BLINDER K, ENNIS M, and KELLER A. Ephaptic interactions in the mammalian olfactory system. *Journal of Neuroscience*, 21: -, 2001.
- BOSTROM N. How long before superintelligence? *Int. Jour. of Future Studies*, 2, 1998.
- BOSTROM N. Are you living in a computer simulation? *Philosophical Quarterly*, 53: 243-255, 2003.
- BOWER JM and BEEMAN D. *The book of genesis: Exploring realistic neural models with the general neural simulation system*. New York: Springer-Verlag, 1998.
- BRAITENBERG V and SCHUZ A. *Cortex: Statistics and geometry of neuronal connectivity*. New York: Springer Verlag, 1998.
- BRETTE R, RUDOLPH M, CARNEVALE T, et al. Simulation of networks of spiking neurons: A review of tools and strategies. *Journal of Computational Neuroscience*, 23: 349-398, 2007.
- BRIGGMAN KL and DENK W. Towards neural circuit reconstruction with volume electron microscopy techniques. *Current Opinion in Neurobiology*, 16: 562-570, 2006.
- BRITT RH and ROSSI GT. Quantitative-analysis of methods for reducing physiological brain pulsations. *Journal of Neuroscience Methods*, 6: 219-229, 1982.
- BROWN IE, SCOTT SH, and LOEB GE. Mechanics of feline soleus: Ii. Design and validation of a mathematical model. *J Muscle Res Cell Motil*, 17: 221-33, 1996.
- BRUNEL N, HAKIM V, ISOPE P, NADAL JP, and BARBOUR B. Optimal information storage and the distribution of synaptic weights: Perceptron versus purkinje cell. *Neuron*, 43: 745-757, 2004.
- BULLOCK TH. Revisiting the concept of identifiable neurons. *Brain Behavior and Evolution*, 55: 236-240, 2000.
- CAI LL, COURTINE G, FONG AJ, et al. Plasticity of functional connectivity in the adult spinal cord. *Philosophical Transactions of the Royal Society B-Biological Sciences*, 361: 1635-1646, 2006.
- CAIANIELLO ER. Outline of a theory of thought process and thinking machines. *J. Theoret. Biol.*, 1: 204-235, 1961.
- CARNEVALE NT and HINES ML. *The neuron book*. Cambridge, UK: Cambridge University Press, 2006.

- CASH AD, ALIEV G, SIEDLAK SL, et al. Microtubule reduction in alzheimer's disease and aging is independent of tau filament formation. *American Journal of Pathology*, 162: 1623-1627, 2003.
- CCORTEX. *Artificial development to build world's biggest spiking neural network*. 2003 <http://www.corticaldb.com/ccortex.asp>.
- CHALMERS DJ. Absent qualia, fading qualia, dancing qualia. In Metzinger T. (Ed.) *Conscious experience*: Imprint Academic, 1995.
- CHANG YM and LUEBKE JI. Electrophysiological diversity of layer 5 pyramidal cells in the prefrontal cortex of the rhesus monkey: In vitro slice studies. *Journal of Neurophysiology*, 98: 2622-2632, 2007.
- CHAO S-H, DOUGHERTY WM, GARBINI JL, and SIDLES JA. Nanometer-scale magnetic resonance imaging. *Review of Scientific Instruments*, 75: 1175-1181, 2004.
- CHEN DT and ZELTZER D. Pump it up: Computer animation of a biomechanically based model of muscle using the finite element method. In Thomas J.J. (Ed.) *Proceedings of the 19th annual conference on computer graphics and interactive techniques*, 1992, pp. 89-98.
- CHEN LY, REX CS, CASALE MS, GALL CM, and LYNCH G. Changes in synaptic morphology accompany actin signaling during ltp. *Journal of Neuroscience*, 27: 5363-5372, 2007.
- CHERNIAK C. The bounded brain: Toward quantitative neuroanatomy. *Journal of Cognitive Neuroscience*, 2: 58-68, 1990.
- CHURCHLAND P and SEJNOWSKI TJ. *The computational brain*: MIT Press, 1992.
- CIOBANU L, SEEBER DA, and PENNINGTON CH. 3d mr microscopy with resolution 3.7 mu m by 3.3 mu m by 3.3 mu m. *Journal of Magnetic Resonance*, 158: 178-182, 2002.
- CIVELLI O. Gpcr deorphanizations: The novel, the known and the unexpected transmitters. *Trends in Pharmacological Sciences*, 26: 15-19, 2005.
- COLOMBELLI J, GRILL SW, and STELZER EHK. Ultraviolet diffraction limited nanosurgery of live biological tissues. *Review of Scientific Instruments*, 75: 472-478, 2004.
- COLONNIER M. The electron-microscopic analysis of the neuronal organization of the cerebral cortex. In Schmitt F., Worden F., Adelman G., and Dennis S. (Eds.), *The organization of the cerebral cortex*. Cambridge: MIT Press, 1981, pp. 125-152.
- COMPAÑO R, MOLENKAMP L, and PAUL DJ. *Technology roadmap for nanoelectronics*. Microelectronics Advanced Research Initiative, 1999
- COTIN S, DELINGETTE H, and AYACHE N. Real-time elastic deformations of soft tissues for surgery simulation. *Ieee Transactions on Visualization and Computer Graphics*, 5: 62-73, 1999.
- CRAGG SJ, NICHOLSON C, KUME-KICK J, TAO L, and RICE ME. Dopamine-mediated volume transmission in midbrain is regulated by distinct extracellular geometry and uptake. *Journal of Neurophysiology*, 85: 1761-1771, 2001.
- CROSSIN KL and KRUSHEL LA. Cellular signaling by neural cell adhesion molecules of the immunoglobulin superfamily. *Developmental Dynamics*, 218: 260-279, 2000.
- CROWN ED, FERGUSON AR, JOYNES RL, and GRAU JW. Instrumental learning within the spinal cord ii. Evidence for central mediation. *Physiology & Behavior*, 77: 259-267, 2002.
- DAISY PROJECT. *Neocortical daisy architectures and graphical models for context-dependent processing*. 2008 <http://daisy.ini.unizh.ch/>.
- DEBENEDICTIS E, KOGGE P, LENT C, NIEMIER M, and STERLING T. *The technology lane on the road to a zettaflops, tr 2006-15*. University of Notre Dame Computer Science and Engineering Faculty, 2006 [www.cse.nd.edu/Reports/2006/TR-2006-15.pdf](http://www.cse.nd.edu/Reports/2006/TR-2006-15.pdf).
- DEBENEDICTIS EP. *Taking asci supercomputing to the end game, sand2004-0959*. Sandia National Laboratories, 2004
- DEBENEDICTIS EP. Reversible logic for supercomputing. In *Proceedings of the 2nd conference on computing frontiers*, 2005, pp. 391-402.

- DENK W and HORSTMANN H. Serial block-face scanning electron microscopy to reconstruct three-dimensional tissue nanostructure. *Plos Biology*, 2: 1900-1909, 2004.
- DI VENTURA B, LEMERLE C, MICHALODIMITRAKIS K, and SERRANO L. From in vivo to in silico biology and back. *Nature*, 443: 527-533, 2006.
- DILLON C and GODA Y. The actin cytoskeleton: Integrating form and function at the synapse. *Annual Review of Neuroscience*, 28: 25-55, 2005.
- DIMA A, SCHOLZ M, and OBERMAYER K. Automatic segmentation and skeletonization of neurons from confocal microscopy images based on the 3-d wavelet transform. *Image Processing, IEEE Transactions on*, 11: 790-801, 2002.
- DIX A. The brain and the web: A quick backup in case of accidents. *Interfaces*, 65: 6-7, 2005.
- DJURFELDT M, JOHANSSON C, EKEBERG Ö, et al. *Massively parallel simulation of brain-scale neuronal network models*. Stockholm: CSC, KTH, 2005 [http://www-03.ibm.com/servers/deepcomputing/pdf/Blue\\_Gene\\_Applications\\_Paper\\_KTH\\_0306.pdf](http://www-03.ibm.com/servers/deepcomputing/pdf/Blue_Gene_Applications_Paper_KTH_0306.pdf).
- DJURFELDT M, LUNDQVIST M, JOHANSSON C, et al. *Project report for blue gene watson consortium days: Massively parallel simulation of brain-scale neuronal network models*. 2006 <http://www-fp.mcs.anl.gov/bgconsortium/Past%20Results/kth%20bgwreport06.pdf>.
- DOAK RB, GRISENTI RE, REHBEIN S, et al. Towards realization of an atomic de broglie microscope: Helium atom focusing using fresnel zone plates. *Physical Review Letters*, 83: 4229-4232, 1999.
- DONIZELLI M, DJITE MA, and LE NOVERE N. Lgicdb: A manually curated sequence database after the genomes. *Nucleic Acids Research*, 34: D267-D269, 2006.
- DOUGLASS JK and WILKENS LA. Directional selectivities of near-field filiform hair mechanoreceptors on the crayfish tailfan (crustacea : Decapoda). *Journal of Comparative Physiology a-Neuroethology Sensory Neural and Behavioral Physiology*, 183: 23-34, 1998.
- DOYLE CA, LONGSON D, HUTCHINSON C, and SIMPSON MDC. Mri of frozen brain tissue: A fresh look at morphometry in schizophrenia. *Schizophrenia Research*, 18: Xg1-Xg1, 1996.
- DREXLER KE. *Engines of creation: The coming era of nanotechnology*: Anchor Books, 1986.
- DREXLER KE. *Nanosystems: Molecular machinery, manufacturing and computation*: Wiley 1992.
- DRUCKMANN S, BANITT Y, GIDON AA, et al. A novel multiple objective optimization framework for constraining conductance-based neuron models by experimental data. *Frontiers in neuroscience*, 1: 7-18, 2007.
- EKEBERG Ö, BLÜMEL M, and BÜSCHGES A. Dynamic simulation of insect walking. *Arthropod Structure & Development*, 33: 287-300, 2004.
- EKEBERG O and GRILLNER S. Simulations of neuromuscular control in lamprey swimming. *Philos Trans R Soc Lond B Biol Sci*, 354: 895-902, 1999.
- EKEBERG O and PEARSON K. Computer simulation of stepping in the hind legs of the cat: An examination of mechanisms regulating the stance-to-swing transition. *J Neurophysiol*, 94: 4256-68, 2005.
- ELIASMITH C. Attractive and in-discrete - a critique of two putative virtues of the dynamicist theory of mind. *Minds and Machines*, 11: 417-426, 2001.
- ELIXSON E. Hypothermia. Cold-water drowning. *Crit Care Nurs Clin North Am.*, 3: 287-292, 1991.
- EMBL-EBI. *Ligand gated ion channel database*. 2008 <http://www.ebi.ac.uk/compneur-srv/LGICdb/LGICdb.php>.
- FEITELSON DG. The supercomputer industry in light of the top500 data. *Computing in Science and Engineering*, 7: 42-47, 2005.
- FELLIN T and CARMIGNOTO G. Neurone-to-astrocyte signalling in the brain represents a distinct multifunctional unit. *Journal of Physiology-London*, 559: 3-15, 2004.

- FENSTERMACHER J and KAYE T. Drug diffusion within the brain. *Annals of the New York Academy of Sciences*, 531: 29-39, 1988.
- FERNANDEZ JW and PANDY MG. Integrating modelling and experiments to assess dynamic musculoskeletal function in humans. *Exp Physiol*, 91: 371-82, 2006.
- FIALA JC. Three-dimensional structure of synapses in the brain and on the web. In *Ijcnm '02. Proceedings of the 2002 international joint conference on neural networks*: IEEE Press, 2002, pp. 1-4.
- FIALA JC. *Synapses.Bu.Edu*. 2007, 2007 <http://synapses.bu.edu/>.
- FIALA JC and HARRIS KM. Extending unbiased stereology of brain ultrastructure to three-dimensional volumes. *Journal of the American Medical Informatics Association*, 8: 1-16, 2001.
- FIELDS RD and ELLISMAN MH. Synaptic morphology and differences in sensitivity. *Science*, 228: 197-199, 1985.
- FORESIGHT NANOTECH INSTITUTE and BATELLE MEMORIAL INSTITUTE. *Productive nanosystems: A technology roadmap*. 2007 <http://www foresight.org/roadmaps/>.
- FORSBERG E. Reversible logic based on electron waveguide y-branch switches. *Nanotechnology*, 15: S298-S302, 2004.
- FORSBERG E and HIEKE K. Electron waveguide y-branch switches controlled by pt/gaas schottky gates. *Physica Scripta*, T101: 158-160, 2002.
- FORTUNE E and ROSE G. Short-term synaptic plasticity as a temporal filter. *Trends Neuroscience*, 24: 381-385, 2001
- FRANK W. *Electron tomography: Three-dimensional imaging with the transmission electron microscope*. New York: Plenum, 1992.
- FREITAS JR RA. *Nanomedicine, volume i: Basic capabilities*. Georgetown, TX: Landes Bioscience, 1999.
- FREITAS JR. RA. The future of computers. *Analog*, 116: 57-73, 1996.
- FREITAS JR. RA. *Nanomedicine, volume iia: Biocompatibility*. Georgetown, TX: Landes Bioscience, 2003.
- FRYE J. *Bluegene test report*. 2004  
[http://brain.unr.edu/publications/NCS\\_BlugGene\\_report\\_07Nov04.pdf](http://brain.unr.edu/publications/NCS_BlugGene_report_07Nov04.pdf).
- FRYE J, ANANTHANARAYANAN R, and MODHA DS. *Towards real-time, mouse-scale cortical simulations*. Salt Lake City, Utah, Feb 22-25 2007, 2007  
<http://www.modha.org/papers/rj10404.pdf>.
- FUJISAKI H, TAKAHASHI S, OHZEKI H, et al. Soft-x-ray damage to biological samples. *Journal of Microscopy-Oxford*, 182: 79-83, 1996.
- FUNKHOUSER T, TSINGOS N, CARLBOM I, et al. A beam tracing method for interactive architectural acoustics. *Journal of the Acoustical Society of America*, 115: 739-756, 2004.
- GAMMAITONI L, HANGGI P, JUNG P, and MARCHESONI F. Stochastic resonance. *Reviews of Modern Physics*, 70: 223-287, 1998.
- GARDNER-MEDWIN AR. Analysis of potassium dynamics in mammalian brain-tissue. *Journal of Physiology-London*, 335: 393-426, 1983.
- GARRIGA A, SPA C, and LOPEZ V. *Computation of the complete acoustic field with finite-differences algorithms*. Budapest, 2005  
[http://www.tecn.upf.es/~agarriga/ARCHIVOS\\_ADAN/fa\\_2005\\_paper.pdf](http://www.tecn.upf.es/~agarriga/ARCHIVOS_ADAN/fa_2005_paper.pdf).
- GELPERIN D and HETZEL B. The growth of software testing. *Communications of the Acm*, 31: 687-695, 1988.
- GEMMELL J, BELL G, and LUEDER R. Mylifebits: A personal database for everything. *Communications of the Acm*, 49: 88-95, 2006.
- GLOVER P and MANSFIELD P. Limits to magnetic resonance microscopy. *Reports on Progress in Physics*, 65: 1489-1511, 2002.

- GOODMAN PH, COURTENAY WILSON E, MACIOKAS JB, et al. *Large-scale parallel simulation of physiologically realistic multicolumn sensory cortex*. 2001  
[http://brain.unr.edu/publications/gwm.largescalecortex\\_01.pdf](http://brain.unr.edu/publications/gwm.largescalecortex_01.pdf).
- GRAY CM, KONIG P, ENGEL AK, and SINGER W. Oscillatory responses in cat visual-cortex exhibit inter-columnar synchronization which reflects global stimulus properties. *Nature*, 338: 334-337, 1989.
- GRIMA R and SCHNELL S. A systematic investigation of the rate laws valid in intracellular environments. *Biophysical Chemistry*, 124: 1-10, 2006.
- GRUTZENDLER J, KASTHURI N, and GAN WB. Long-term dendritic spine stability in the adult cortex. *Nature*, 420: 812-816, 2002.
- GUPTA A, WANG Y, and MARKRAM H. Organizing principles for a diversity of gabaergic interneurons and synapses in the neocortex. *Science*, 287: 273-278, 2000.
- GUSTAFSSON MGL. Nonlinear structured-illumination microscopy: Wide-field fluorescence imaging with theoretically unlimited resolution. *Proceedings of the National Academy of Sciences of the United States of America*, 102: 13081-13086, 2005.
- GUTMAN GA, CHANDY KG, GRISSMER S, et al. International union of pharmacology. Liii. Nomenclature and molecular relationships of voltage-gated potassium channels. *Pharmacological Reviews*, 57: 473-508, 2005.
- HAGAN S, HAMEROFF SR, and TUSZYNSKI JA. Quantum computation in brain microtubules: Decoherence and biological feasibility. *Physical Review E*, 65: -, 2002.
- HAMEROFF SR. *Ultimate computing: Biomolecular consciousness and nanotechnology*: Elsevier Science Publishers, 1987.
- HAMMARLUND P and EKEBERG O. Large neural network simulations on multiple hardware platforms. *Journal of Computational Neuroscience*, 5: 443-459, 1998.
- HANLON EB, MANOHARAN R, KOO TW, et al. Prospects for in vivo raman spectroscopy. *Physics in Medicine and Biology*, 45: R1-R59, 2000.
- HANSON R. If uploads come first: The crack of a future dawn. *Extropy*, 6, 1994.
- HANSON R. The next really big enormous thing. *Future Brief*, October 6, 2004.
- HANSON R. Economics of brain emulations. In Healey P. (Ed.) *Tomorrow's people - proceedings of the james martin institute's first world forum*: EarthScan, 2008a.
- HANSON R. Economics of the singularity. *IEEE Spectrum*: 37-42, 2008b.
- HARDMAN JG, BEDFORTH NM, AHMED AB, MAHAJAN RP, and AITKENHEAD AR. A physiology simulator: Validation of its respiratory components and its ability to predict the patient's response to changes in mechanical ventilation. *British Journal of Anaesthesia*, 81: 327-332, 1998.
- HARRIS FC, BAURICK J, FRYE J, et al. *A novel parallel hardware and software solution for a large-scale biologically realistic cortical simulation*. Goodman Brain Computation Lab, University of Nevada, 2002
- HARRIS K and STEVENS J. Dendritic spines of ca1 pyramidal cells in the rat hippocampus: Serial electron microscopy with reference to their biophysical characteristics. *J.Neurosci*, 9: 2982-2997, 1989.
- HARRISON J, RENSINK RA, and VAN DE PANNE M. Obscuring length changes during animated motion. *Acm Transactions on Graphics*, 23: 569-573, 2004.
- HARVEY CD and SVOBODA K. Locally dynamic synaptic learning rules in pyramidal neuron dendrites. *Nature*, 450: 1195-U3, 2007.
- HAYMAN S. The mcculloch-pitts model. *Neural Networks*, 6: 4438-4439, 1999.
- HAYWORTH KJ. *Single brain physical slice library proposal: Creating a complete human neural connectivity database via sparse, automatically-directed ultramicroscopic imaging using an automated retrieval brain slice storage system*. 2002  
<http://www.extremeneuroanatomy.com/PhysicalSliceLibraryProposal.pdf>.

- HAYWORTH KJ. *Atlum project home page*. 2007, 2007  
[http://www.mcb.harvard.edu/lichtman/ATLUM/ATLUM\\_web.htm](http://www.mcb.harvard.edu/lichtman/ATLUM/ATLUM_web.htm).
- HAYWORTH KJ, KASHTURI N, SCHALEK R, and LICHTMAN JW. *Automating the collection of ultrathin serial sections for large volume tom reconstructions*. Chicago, 2006
- HERZ AVM, GOLLISCH T, MACHENS CK, and JAEGER D. Modeling single-neuron dynamics and computations: A balance of detail and abstraction. *Science*, 314: 80-85, 2006.
- HIGGINS TV. Computing with photons at the speed of light. *Laser Focus World*, 31: 72-77, 1995.
- HILLERBRAND R. Scale separation as a condition for quantitative modelling. Why mathematics works for some problems and fails for others. *Synthese*, 2008.
- HINES M, MARKRAM H, and SCHUERMAN F. Fully implicit parallel simulation of single neurons. *J Comp Neurosci*, 2008.
- HODGKIN A and HUXLEY A. A quantitative description of membrane current and its application to conduction and excitation in nerve. *J Physiol.*, 117: 500-544, 1952.
- HOKFELT T, BROBERGER C, XU ZQD, et al. Neuropeptides - an overview. *Neuropharmacology*, 39: 1337-1356, 2000.
- HOLST B and ALLISON W. An atom-focusing mirror. *Nature*, 390: 244-244, 1997.
- HOLTMAAT AJGD, TRACHTENBERG JT, WILBRECHT L, et al. Transient and persistent dendritic spines in the neocortex in vivo. *Neuron*, 45: 279-291, 2005.
- HOUWELING AR and BRECHT M. Behavioural report of single neuron stimulation in somatosensory cortex. *Nature*, 451: 65-U8, 2008.
- HOWELL FW, DYHRFJELD-JOHNSEN J, MAEX R, GODDARD N, and DE SCHUTTER E. A large-scale model of the cerebellar cortex using pgenesis. *Neurocomputing*, 32: 1041-1046, 2000.
- HULL C, STUDHOLME K, YAZULLA S, and VON GERSDORFF H. Diurnal changes in exocytosis and the number of synaptic ribbons at active zones of an on-type bipolar cell terminal. *Journal of Neurophysiology*, 96: 2025-2033, 2006.
- HUMPHERY-SMITH I. A human proteome project with a beginning and an end. *Proteomics*, 4: 2519-2521, 2004.
- IMRE A, CSABA G, JI L, et al. Majority logic gate for magnetic quantum-dot cellular automata. *Science*, 311: 205-208, 2006.
- INUI K, NAKAZAWA S, YOSHINO J, and UKAI H. Endoscopic mri. *Pancreas*, 16: 413-417, 1998.
- ITO A and SHINOHARA K. Image blurring by thermal-diffusion in the observation of hydrated biomolecules with soft-x-ray microscopy. *Cell Structure and Function*, 17: 209-212, 1992.
- ITRS07. *International technology roadmap for semiconductors*,  
<http://www.Itrs.Net/links/2007itrs/home2007.Htm>. 2007
- IVANCEVIC V and BEAGLEY N. *Determining the acceptable limits of head mounted loads*. Land Operations Division, Systems Sciences Laboratory, Australian Defence Science and Technology Organisation, 2004
- IZHIKEVICH EM. Simple model of spiking neurons. *Ieee Transactions on Neural Networks*, 14: 1569-1572, 2003.
- IZHIKEVICH EM. Which model to use for cortical spiking neurons? *Ieee Transactions on Neural Networks*, 15: 1063-1070, 2004.
- IZHIKEVICH EM. *Simulation of large-scale brain models*. 2007, 2005  
[http://vesicle.nsi.edu/users/izhikevich/human\\_brain\\_simulation/Blue\\_Brain.htm#Simulation%20of%20Large-Scale%20Brain%20Models](http://vesicle.nsi.edu/users/izhikevich/human_brain_simulation/Blue_Brain.htm#Simulation%20of%20Large-Scale%20Brain%20Models).
- IZHIKEVICH EM. *Dynamical systems in neuroscience: The geometry of excitability and bursting*. Cambridge, Massachusetts: MIT Press, 2007.
- JACOBSEN C. Soft x-ray microscopy. *Trends in Cell Biology*, 9: 44-47, 1999.
- JELINEK HF and FERNANDEZ E. Neurons and fractals: How reliable and useful are calculations of fractal dimensions? *Journal of Neuroscience Methods*, 81: 9-18, 1998.

- JOHANSSON C and LANSNER A. Towards cortex sized artificial neural systems. *Neural Networks*, 20: 48-61, 2007.
- KALISMAN N, SILBERBERG G, and MARKRAM H. Deriving physical connectivity from neuronal morphology. *Biological Cybernetics*, 88: 210-218, 2003.
- KALISMAN N, SILBERBERG G, and MARKRAM H. The neocortical microcircuit as a tabula rasa. *Proceedings of the National Academy of Sciences of the United States of America*, 102: 880-885, 2005.
- KASPER EM, LARKMAN AU, LUBKE J, and BLAKEMORE C. Pyramidal neurons in layer-5 of the rat visual-cortex .1. Correlation among cell morphology, intrinsic electrophysiological properties, and axon targets. *Journal of Comparative Neurology*, 339: 459-474, 1994.
- KAUFMAN A, DROR G, MEILIJSON I, and RUPPIN E. Gene expression of caenorhabditis elegans neurons carries information on their synaptic connectivity. *Plos Computational Biology*, 2: 1561-1567, 2006.
- KEREN N, PELED N, and KORNGREEN A. Constraining compartmental models using multiple voltage recordings and genetic algorithms. *Journal of Neurophysiology*, 94: 3730-3742, 2005.
- KEYHANI K, SCHERER PW, and MOZELL MM. A numerical model of nasal odorant transport for the analysis of human olfaction. *Journal of Theoretical Biology*, 186: 279-301, 1997.
- KIKUCHI S, FUJIMOTO K, KITAGAWA N, et al. Kinetic simulation of signal transduction system in hippocampal long-term potentiation with dynamic modeling of protein phosphatase 2a. *Neural Networks*, 16: 1389-1398, 2003.
- KIRBAS C and QUEK F. A review of vessel extraction techniques and algorithms. *Acm Computing Surveys*, 36: 81-121, 2004.
- KLATZKY RL, LEDERMAN SJ, HAMILTON C, and GRINDLEY M. Feeling textures through a probe: Effects of probe and surface geometry and exploratory factors. *Perception & Psychophysics*, 65: 613-631, 2003.
- KOCH C and HEPP K. Quantum mechanics in the brain. *Nature*, 440: 611-612, 2006.
- KOENE RA. *Netmorph*. 2008 <http://netmorph.org/>.
- KOH W and MCCORMICK BH. *Specifications for volume data acquisition in three-dimensional light microscopy, technical report tr2003-7-5*. College Station, TX: Department of Computer Science, Texas A&M University, 2003
- KONDO Y, KOSHIBA Y, ARIMA Y, et al. A 1.2 gflops neural network chip for high-speed neural network servers. *Ieee Journal of Solid-State Circuits*, 31: 860-864, 1996.
- KOUZNETSOV D, OBERST H, NEUMANN A, et al. Ridged atomic mirrors and atomic nanoscope. *Journal of Physics B-Atomic Molecular and Optical Physics*, 39: 1605-1623, 2006.
- KOZLOV AK, LANSNER A, GRILLNER S, and KOTALESKI JH. A hemicord locomotor network of excitatory interneurons: A simulation study. *Biological Cybernetics*, 96: 229-243, 2007.
- KOZLOV AS, ANGULO MC, AUDINAT E, and CHARPAK S. Target cell-specific modulation of neuronal activity by astrocytes. *Proceedings of the National Academy of Sciences of the United States of America*, 103: 10058-10063, 2006.
- KRAFFT C. Bioanalytical applications of raman spectroscopy. *Analytical and Bioanalytical Chemistry*, 378: 60-62, 2004.
- KRAFFT C, KNETSCHKE T, SIEGNER A, FUNK RHW, and SALZER R. Mapping of single cells by near infrared raman microspectroscopy. *Vibrational Spectroscopy*, 32: 75-83, 2003.
- KRIMER LS, ZAITSEV AV, CZANNER G, et al. Cluster analysis-based physiological classification and morphological properties of inhibitory neurons in layers 2-3 of monkey dorsolateral prefrontal cortex. *Journal of Neurophysiology*, 94: 3009-3022, 2005.
- KRNJEVIC K. Ephaptic interactions: A significant mode of communications in the brain. *News in Physiological Sciences*, 1: 28-29, 1986.



- KRUIT P. High throughput electron lithography with the multiple aperture pixel by pixel enhancement of resolution concept. *Journal of Vacuum Science & Technology B*, 16: 3177-3180, 1998.
- KULLMANN DM. Silent synapses: What are they telling us about long-term potentiation? *Philosophical Transactions of the Royal Society of London Series B-Biological Sciences*, 358: 727-733, 2003.
- KURZWEIL R. *The age of spiritual machines*. New York: Viking, 1999.
- KURZWEIL R. *The singularity is near: When humans transcend biology*: Viking Press, 2005.
- KUZIRIAN AM and LEIGHTON SB. Oxygen plasma-etching of entire block faces improves the resolution and usefulness of serial scanning electron-microscopic images. *Scanning Electron Microscopy*: 1877-1885, 1983.
- KWON J, MAYERICH D, CHOE Y, and MCCORMICK BH. Automated lateral sectioning for knife-edge scanning microscopy. In *Ieee international symposium on biomedical imaging: From nano to macro*, 2008.
- LANDAUER TK. How much do people remember - some estimates of the quantity of learned information in long-term-memory. *Cognitive Science*, 10: 477-493, 1986.
- LEDO A, FRADE J, BARBOSA RM, and LARANJINHA J. Nitric oxide in brain: Diffusion, targets and concentration dynamics in hippocampal subregions. *Molecular Aspects of Medicine*, 25: 75-89, 2004.
- LEE WCA, HUANG H, FENG GP, et al. Dynamic remodeling of dendritic arbors in gabaergic interneurons of adult visual cortex. *Plos Biology*, 4: 271-280, 2006.
- LEENDERS KL, PERANI D, LAMMERTSMA AA, et al. Cerebral blood-flow, blood-volume and oxygen utilization - normal values and effect of age. *Brain*, 113: 27-47, 1990.
- LEIGHTON SB. Sem images of block faces, cut by a miniature microtome within the sem - a technical note. *Scanning Electron Microscopy*: 73-76, 1981.
- LEITL E. *Neurosuspension and uploading*. 2007, 1995  
[http://www.aleph.se/Trans/Individual/Cryonics/neurosusp\\_upload.txt](http://www.aleph.se/Trans/Individual/Cryonics/neurosusp_upload.txt).
- LESTIENNE R. Determination of the precision of spike timing in the visual cortex of anaesthetised cats. *Biological Cybernetics*, 74: 55-61, 1996.
- LEVENSON JM and SWEATT JD. Epigenetic mechanisms in memory formation. *Nature Reviews Neuroscience*, 6: 108-118, 2005.
- LI C, YU J, and LIAO X. Chaos in a three-neuron hysteresis hopfield-type neural networks. *Physics Letters A*, 285: 368-372, 2001.
- LI KW. Proteomics of synapse. *Analytical and Bioanalytical Chemistry*, 387: 25-28, 2007.
- LI XQ, WU YW, STEEL D, et al. An all-optical quantum gate in a semiconductor quantum dot. *Science*, 301: 809-811, 2003.
- LIEBERMAN M, CHELLAMMA S, VARUGHESE B, et al. Quantum-dot cellular automata at a molecular scale. *Molecular Electronics Ii*, 960: 225-239, 2002.
- LIKHAREV KK and SEMENOV VK. Rsfq logic/memory family: A new josephson-junction technology for sub-terahertz-clock-frequency digital systems. *Applied Superconductivity, IEEE Transactions on*, 1: 3-28, 1991.
- LIN MC and OTADUY MA. Sensation-preserving haptic rendering. *Ieee Computer Graphics and Applications*, 25: 8-11, 2005.
- LITT A, ELIASMITH C, KROON FW, WEINSTEIN S, and THAGARD P. Is the brain a quantum computer? *Cognitive Science*, 30: 593-603, 2006.
- LLOYD DG and BESIER TF. An emg-driven musculoskeletal model to estimate muscle forces and knee joint moments in vivo. *J Biomech*, 36: 765-76, 2003.
- LONDON M and HAUSSER M. Dendritic computation. *Annual Review of Neuroscience*, 28: 503-532, 2005.
- LONGSON D, HUTCHINSON CE, DOYLE CA, et al. Use of mri for measuring structures in frozen postmortem brain. *Brain Research Bulletin*, 38: 457-460, 1995.

- LOVE S and COAKHAM HB. Trigeminal neuralgia - pathology and pathogenesis. *Brain*, 124: 2347-2360, 2001.
- LUČIĆ V, FÖRSTER F, and BAUMEISTER W. Structural studies by electron tomography: From cells to molecules. *Annual Review of Biochemistry*, 74: 833-65, 2005.
- MA YY, HU H, BERREBI AS, MATHERS PH, and AGMON A. Distinct subtypes of somatostatin-containing neocortical interneurons revealed in transgenic mice. *Journal of Neuroscience*, 26: 5069-5082, 2006.
- MABUCHI M, SHIMADA J, OKAMOTO K, et al. Time-resolved fluorescence spectroscopy of dopamine in single cells. In Lakowicz J.R. and Thompson R.B. (Eds.), *Proceedings of SPIE - volume 4252: Advances in fluorescence sensing technology v*: SPIE, 2001, pp. 140-148.
- MACLEOD KM, HORIUCHI TK, and CARR CE. A role for short-term synaptic facilitation and depression in the processing of intensity information in the auditory brain stem. *J Neurophysiol*, 97: 2863-74, 2007.
- MAGENAT-THALMANN N and CORDIER F. Construction of a human topological model from medical data. *Ieee Transactions on Information Technology in Biomedicine*, 4: 137-143, 2000.
- MAHVASH M and HAYWARD V. High-fidelity haptic synthesis of contact with deformable bodies. *Ieee Computer Graphics and Applications*, 24: 48-55, 2004.
- MALICKAS A. *Gradual uploading as a cognition of mind*. 2007, 1996  
<http://www.aleph.se/Trans/Global/Uploading/gupload.html>.
- MALINSKI T, TAHA Z, GRUNFELD S, et al. Diffusion of nitric-oxide in the aorta wall monitored in-situ by porphyrinic microsensors. *Biochemical and Biophysical Research Communications*, 193: 1076-1082, 1993.
- MARKRAM H. *Neocortical microcircuit database*. EPFL, 2005 <http://microcircuit.epfl.ch/>.
- MARKRAM H. The blue brain project. *Nature Reviews Neuroscience*, 7: 153-160, 2006.
- MARKRAM H, LUBKE J, FROTSCHER M, and SAKMANN B. Regulation of synaptic efficacy by coincidence of postsynaptic aps and epsps. *Science*, 275: 213-215, 1997.
- MARRONE DF. Ultrastructural plasticity associated with hippocampal-dependent learning: A meta-analysis. *Neurobiology of Learning and Memory*, 87: 361-371, 2007.
- MARRONE DF and PETIT TL. The role of synaptic morphology in neural plasticity: Structural interactions underlying synaptic power. *Brain Research Reviews*, 38: 291-308, 2002.
- MASON A and LARKMAN A. Correlations between morphology and electrophysiology of pyramidal neurons in slices of rat visual-cortex .2. Electrophysiology. *Journal of Neuroscience*, 10: 1415-1428, 1990.
- MATTIA M and GIUDICE PD. Efficient event-driven simulation of large networks of spiking neurons and dynamical synapses. *Neural Computation*, 12: 2305-2329, 2000.
- MAYERICH D, ABBOTT L, and MCCORMICK B. *Knife-edge scanning microscopy for imaging and reconstruction of three-dimensional anatomical structures of the mouse brain*. 2008
- MAYERICH D, MCCORMICK BH, and KEYSER J. Noise and artifact removal in knife-edge scanning microscopy. In Piscataway N. (Ed.) *Proceedings of 2007 ieee international symposium on biomedical imaging: From nano to macro*: IEEE Press, 2007.
- MAYERICH DM and KEYSER J. Filament tracking and encoding for complex biological networks. In *Proceedings of acm symposium on solid and physical modeling*, 2008, pp. 353-358.
- MCCALLUM JC. *Cpu price performance 1944-2003*. 2007, 2003 <http://www.jcmit.com/cpu-performance.htm>.
- MCCALLUM JC. *Disk drive prices (1955-2007)*. 2007, 2007a <http://www.jcmit.com/diskprice.htm>.
- MCCALLUM JC. *Memory prices (1957-2007)*. 2007, 2007b  
<http://www.jcmit.com/memoryprice.htm>.
- MCCLUNG CA and NESTLER EJ. Neuroplasticity mediated by altered gene expression. *Neuropsychopharmacology*, 33: 3-17, 2008.

- MCCORMICK BH. Brain tissue scanner enables brain microstructure surveys. *Neurocomputing*, 44: 1113-1118, 2002a.
- MCCORMICK BH. *Development of the brain tissue scanner*. Department of Computer Science, Texas A&M University, 2002b
- MCCORMICK BH, KOH W, CHOE Y, et al. Construction of anatomically correct models of mouse brain networks. *Neurocomputing*, 58-60: 379-386, 2004.
- MCCULLOCH WS and PITTS WH. A logical calculus of the ideas immanent in nervous activity. *. Bulletin of Mathematical Biophysics*, 5: 115-133, 1943.
- MCDUGALL MP and WRIGHT SM. Initial results in wide-field 3d mr microscopy using parallel imaging. In *Biomedical imaging: From nano to macro, 2007. Isbi 2007. 4th ieee international symposium on: IEEE, 2007*, pp. 1072-1075.
- MCGUIGAN M. *Graphics turing test*, *arxiv:Cs.Gr/0603132*. 2007, 2006  
<http://arxiv.org/abs/cs.GR/0603132>.
- MEHRTASH N, JUNG D, HELLMICH HH, et al. Synaptic plasticity in spiking neural networks ((spinn)-i-2): A system approach. *Ieee Transactions on Neural Networks*, 14: 980-992, 2003.
- MEINDL JD, CHEN Q, and DAVIS JA. Limits on silicon nanoelectronics for terascale integration. *Science*, 293: 2044-2049, 2001.
- MERKLE RC. Energy limits to the computational power of the human brain. *Foresight Update*, 6, 1989a.
- MERKLE RC. *Large scale analysis of neural structures*. Palo Alto, California: Xerox Palo Alto Research Center, 1989b <http://www.merkle.com/merkleDir/brainAnalysis.html>.
- MERKLE RC. Two types of mechanical reversible logic. *Nanotechnology*, 4: 114-131, 1993.
- MERKLE RC. The molecular repair of the brain. *Cryonics magazine*, 15, 1994.
- MERKLE RC and DREXLER KE. Helical logic. *Nanotechnology*, 7: 325-339, 1996.
- METHE O, SPRING H, GUTTMANN P, et al. Transmission x-ray microscopy of intact hydrated ptk2 cells during the cell cycle. *Journal of Microscopy-Oxford*, 188: 125-135, 1997.
- MICHELSON S and COLE M. The future of predictive biosimulation in drug discovery. *Expert Opinion on Drug Discovery*, 2: 515-523, 2007.
- MICHEVA KD and SMITH SJ. Array tomography: A new tool for imaging the molecular architecture and ultrastructure of neural circuits. *Neuron*, 55: 25-36, 2007.
- MIGLIORE M, CANNIA C, LYTTON WW, MARKRAM H, and HINES ML. Parallel network simulations with neuron. *Journal of Computational Neuroscience*, 21: 119-129, 2006.
- MILLER CA and SWEATT JD. Covalent modification of DNA regulates memory formation. *Neuron*, 53: 857-869, 2007.
- MIZUTANI R, TAKEUCHI A, HARA T, UESUGI K, and SUZUKI Y. Computed tomography imaging of the neuronal structure of drosophila brain. *Journal of Synchrotron Radiation*, 14: 282-287, 2007.
- MOLL M and MIIKKULAINEN R. Convergence-zone episodic memory: Analysis and simulations. *Neural Networks*, 10: 1017-1036, 1997.
- MOORE JW and HINES ML. *Simulations with neuron*, 1994.
- MORAVEC H. When will computer hardware match the human brain? *Journal of Evolution and Technology*, 1, 1998.
- MORAVEC H. *Robot: Mere machine to transcendent mind*. New York: Oxford University Press, 1999.
- MORAVEC H. *Mind children: The future of robot and human intelligence*: Harvard University Press, 1988.
- MORRISON A, MEHRING C, GEISEL T, AERTSEN A, and DIESMANN MA. Advancing the boundaries of high-connectivity network simulation with distributed computing. *Neural Computation*, 17: 1776-1801, 2005.

- MULDERS JL, KNOTT G, and LICH BH. *Dualbeam slice & view: Practical aspects for collecting 3d cortex image data*. Chicago, 2006
- MULLER-TIDOW C, SCHWABLE J, STEFFEN B, et al. High-throughput analysis of genome-wide receptor tyrosine kinase expression in human cancers identifies potential novel drug targets. *Clinical Cancer Research*, 10: 1241-1249, 2004.
- MUOTRI AR and GAGE FH. Generation of neuronal variability and complexity. *Nature*, 441: 1087-1093, 2006.
- NADAL J-P and TOULOUSE G. Information storage in sparsely coded memory nets. *Network: Computation in Neural Systems*, 1: 61-74, 1990.
- NADAL JP. Associative memory - on the (puzzling) sparse coding limit. *Journal of Physics a-Mathematical and General*, 24: 1093-1101, 1991.
- NADIM F and MANOR Y. The role of short-term synaptic dynamics in motor control. *Curr Opin Neurobiol*, 10: 683-90, 2000.
- NANOROADMAP PROJECT. *Roadmaps at 2015 on nanotechnology application in the sectors of: Materials, health & medical systems, energy*. European Commission, 2006  
<http://www.nanoroadmap.it/>.
- NELLIST PD, CHISHOLM MF, DELLBY N, et al. Direct sub-angstrom imaging of a crystal lattice. *Science*, 305: 1741-1741, 2004.
- NEUMANN JV. *The computer and the brain*. New Haven: Yale University Press, 1958.
- NEWMAN EA and ZAHS KR. Modulation of neuronal activity by glial cells in the retina. *Journal of Neuroscience*, 18: 4022-4028, 1998.
- NICHOLSON C. Diffusion and related transport mechanisms in brain tissue. *Reports on Progress in Physics*, 64: 815-884, 2001.
- NORDHAUS WD. *The progress of computing*. 2001 <http://ssrn.com/abstract=285168>.
- NUSBAUM MP and BEENHAKKER MP. A small-systems approach to motor pattern generation. *Nature*, 417: 343-350, 2002.
- OBERST H, KOUZNETSOV D, SHIMIZU K, FUJITA J, and SHIMIZU F. Fresnel diffraction mirror for an atomic wave. *Physical Review Letters*, 94: -, 2005.
- ORD T. The many forms of hypercomputation. *Applied Mathematics and Computation*, 178: 143-153, 2006.
- ORTOLEVA P, BERRY E, BRUN Y, et al. The karyote® physico-chemical genomic, proteomic, metabolic cell modeling system. *OMICS*, 7: 269-283, 2003.
- PAJCINI V, MUNRO CH, BORMETT RW, WITKOWSKI RE, and ASHER SA. Uv raman microspectroscopy: Spectral and spatial selectivity with sensitivity and simplicity. *Applied Spectroscopy*, 51: 81-86, 1997.
- PALAY SL, MCGEE-RUSSELL SM, GORDON JR. S, and GRILLO MA. Fixation of neural tissues for electron microscopy by perfusion with solutions of osmium tetroxide. *The Journal of Cell Biology*, 12, 1962.
- PARFIT D. *Reasons and persons*: Oxford University Press, 1984.
- PARPURA V, TONG W, YEUNG ES, and HAYDON PG. Laser-induced native fluorescence (linf) imaging of serotonin depletion in depolarized neurons. *Journal of Neuroscience Methods*, 82: 151-158, 1998.
- PEARSON K, EKEBERG Ö, and BUSCHGES A. Assessing sensory function in locomotor systems using neuro-mechanical simulations. *TRENDS in Neurosciences*, 29: 625+631, 2006.
- PENCZEK P, MARKO M, BUTTLE K, and FRANK J. Double-tilt electron tomography. *Ultramicroscopy*, 60: 393-410, 1995.
- PENROSE R. *The emperor's new mind* New York: Oxford University Press, 1989.
- PEREA G and ARAQUE A. Properties of synaptically evoked astrocyte calcium signal reveal synaptic information processing by astrocytes. *Journal of Neuroscience*, 25: 2192-2203, 2005.
- PETERS A. Thalamic input to the cerebral cortex. *Trends Neurosci.*, 2: 1183-1185, 1979.

- PETERS A and PALAY SL. The morphology of synapses. *Journal of Neurocytology*, 25: 687-700, 1996.
- PFEIFFER J, JOHNSON D, and NEHRKE K. Oscillatory transepithelial h<sup>+</sup> flux regulates a rhythmic behavior in c. *Elegans*. *Current Biology*, 18: 297-302, 2008.
- PICKARD DS, GROVES TR, MEISBURGER WD, CRANE T, and PEASE RF. Distributed axis electron beam technology for maskless lithography and defect inspection. *Journal of Vacuum Science & Technology B*, 21: 2834-2838, 2003.
- PLESSER HE, EPPLER JM, MORRISON A, DIESMANN M, and GEWALTIG M-O. *Efficient parallel simulation of large-scale neuronal networks on clusters of multiprocessor computers*. Kermarrec A.-M., Bougé L., and Priol T.: 672-681, 2007
- PUPPELS GJ, OLMINKHOF JHF, SEGERSNOLTEN GMJ, et al. Laser irradiation and raman-spectroscopy of single living cells and chromosomes - sample degradation occurs with 514.5nm but not with 660nm laser-light. *Experimental Cell Research*, 195: 361-367, 1991.
- RAGHUVANSHI N and LIN MC. *Interactive sound synthesis for large scale environments*. Redwood City, California: ACM Press: 101 - 108 2006
- RAGHUVANSHI N and LIN MC. Physically based sound synthesis for large-scale virtual environments. *Ieee Computer Graphics and Applications*, 27: 14-18, 2007.
- RALL W. Theory physiological properties of dendrites. *Annals of the New York Academy of Sciences*, 96: 1071-&, 1962.
- RALSTON TS, MARKS DL, CARNEY PS, and BOPPART SA. Interferometric synthetic aperture microscopy. *Nature Physics*, 3: 129-134, 2007.
- REHN M and LANSNER A. Sequence memory with dynamical synapses. *Neurocomputing*, 58-60: 271-278, 2004.
- REUTSKIY S, ROSSONI E, and TIROZZI B. Conduction in bundles of demyelinated nerve fibers: Computer simulation. *Biological Cybernetics*, 89: 439-448, 2003.
- RICE ME. Distinct regional differences in dopamine-mediated volume transmission. *Volume Transmission Revisited*, 125: 277-290, 2000.
- RIEKE F, WARLAND D, DE RUYTER VAN STEVENINCK R, and BIALEK W. *Spikes - exploring the neural code*. Cambridge, MA.: MIT Press, 1996.
- ROBLEDO L, ELZERMAN J, JUNDT G, et al. Conditional dynamics of interacting quantum dots. *Science*, 320: 772-775, 2008.
- ROBLES-DE-LA-TORRE G. The importance of the sense of touch in virtual and real environments. *Ieee Multimedia*, 13: 24-30, 2006.
- ROSA LP and FABER J. Quantum models of the mind: Are they compatible with environment decoherence? *Physical Review E*, 70: -, 2004.
- RUECKES T, KIM K, JOSELEVICH E, et al. Carbon nanotube-based nonvolatile random access memory for molecular computing. *Science*, 289: 94-97, 2000.
- RUGAR D, BUDAKIAN R, MAMIN HJ, and CHUI BW. Single spin detection by magnetic resonance force microscopy. *Nature*, 430: 329-32, 2004.
- RUMELHART DE, MCCLELLAND JL, and THE PDP RESEARCH GROUP. *Parallel distributed processing: Explorations in the microstructure of cognition*. Cambridge: MIT Press, 1986.
- SAKAKURA M, KAJIYAMA S, TSUTSUMI M, et al. Femtosecond pulsed laser as a microscalpel for microdissection and isolation of specific sections from biological samples. *Japanese Journal of Applied Physics Part 1-Regular Papers Brief Communications & Review Papers*, 46: 5859-5864, 2007.
- SALIO C, LOSSI L, FERRINI F, and MERIGHI A. Neuropeptides as synaptic transmitters. *Cell and Tissue Research*, 326: 583-598, 2006.
- SANDIA NATIONAL LABORATORIES. *One million trillion 'flops' per second targeted by new institute for advanced architectures*. 2008  
<http://www.sandia.gov/news/resources/releases/2008/exaflop.html>.

- SANTAMARÍA-PANG A, BILDEA TS, COLBERT C, SAGGAU P, and KAKADIARIS IA. Towards segmentation of irregular tubular structures in 3d confocal microscope images. In *Proc. Of the miccai workshop in microscopic image analysis and applications in biology (miaab), denmark, copenhagen, oct 1-6, 2006*, 2006.
- SAWCHUK AA and STRAND TC. Digital optical computing. *Proceedings of the IEEE*, 72: 758-779, 1984.
- SAXE MD, MALLERET G, VRONSKAYA S, et al. Paradoxical influence of hippocampal neurogenesis on working memory. *PNAS*, 104 4642-4646 2007.
- SCHAFF J, SLEPCHENKO B, and MORGAN F. *Virtual cell*. 2001 <http://www.nrcam.uchc.edu/>.
- SCHEEPERS F, PARENT RE, CARLSON WE, and MAY SF. Anatomy-based modeling of the human musculature. In Owen G.S., Whitted T., and Mones-Hatta; B. (Eds.), *Proceedings of the 24th annual conference on computer graphics and interactive techniques*, 1997, pp. 163-172.
- SCHMITT O, MODERSITZKI J, HELDMANN S, WIRTZ S, and FISCHER B. Image registration of sectioned brains. *International Journal of Computer Vision*, 73: 5-39, 2007.
- SCHNELL S and TURNER TE. Reaction kinetics in intracellular environments with macromolecular crowding: Simulations and rate laws. *Progress in Biophysics & Molecular Biology*, 85: 235-260, 2004.
- SCHULZ DJ, GOAILLARD JM, and MARDER E. Variable channel expression in identified single and electrically coupled neurons in different animals. *Nature Neuroscience*, 9: 356-362, 2006.
- SCHULZ DJ, GOAILLARD JM, and MARDER EE. Quantitative expression profiling of identified neurons reveals cell-specific constraints on highly variable levels of gene expression. *Proceedings of the National Academy of Sciences of the United States of America*, 104: 13187-13191, 2007.
- SCHUMAN EM and MADISON DV. Locally distributed synaptic potentiation in the hippocampus. *Science*, 263: 532-536, 1994.
- SEARLE JR. Minds, brains, and programs. *Behavioral and Brain Sciences*, 3: 417-425, 1980.
- SEITZ BTJ. *The great gray ravelled knot*. 2007  
[http://www.geocities.com/rnseitz/The\\_Great\\_Gray\\_Ravelled\\_Knot.htm](http://www.geocities.com/rnseitz/The_Great_Gray_Ravelled_Knot.htm).
- SENN W, MARKRAM H, and TSODYKS M. An algorithm for modifying neurotransmitter release probability based on pre- and postsynaptic spike timing. *Neural Computation*, 13: 35-67, 2001.
- SERRANO L. Synthetic biology: Promises and challenges. *Molecular Systems Biology*, 3: -, 2007.
- SHAOJUAN Z and HAMMARSTROM D. Simulation of associative neural networks. In *Proceedings of the 9th international conference on neural information processing, 2002. Iconip '02.*, 2002, pp. 1639-1643.
- SHEPHERD GM. The human sense of smell: Are we better than we think? *Plos Biology*, 2: 572-575, 2004.
- SHEPHERD GMG, STEPANYANTS A, BUREAU I, CHKLOVSKII D, and SVOBODA K. Geometric and functional organization of cortical circuits. *Nature Neuroscience*, 8: 782-790, 2005.
- SHIMIZU F and FUJITA J. Reflection-type hologram for atoms. *Physical Review Letters*, 88: -, 2002.
- SIDIROPOULOU K, PISSADAKI EK, and POIRAZI P. Inside the brain of a neuron. *EMBO Rep*, 7: 886-92, 2006.
- SIEGELMANN HT and SONTAG ED. On the computational power of neural nets. *Journal of Computer and System Sciences*, 50: 132-150, 1995.
- SILBERBERG G, GUPTA A, and MARKRAM H. Stereotypy in neocortical microcircuits. *TRENDS in Neurosciences*, 25: 227-230, 2002.
- SINGLE S and BORST A. Dendritic integration and its role in computing image velocity. *Science*, 281: 1848-1850, 1998.
- SPORNS O, TONONI G, and KÖTTER R. The human connectome: A structural description of the human brain. *Plos Computational Biology*, 1: 245-251, 2005.

- STEFANOV A, GISIN N, GUINNARD O, GUINNARD L, and ZBINDEN H. Optical quantum random number generator. *Journal of Modern Optics*, 47: 595-598, 2000.
- STEPANYANTS A, HOF PR, and CHKLOVSKII DB. Geometry and structural plasticity of synaptic connectivity. *Neuron*, 34: 275-288, 2002.
- STROHMAIER E and MEUER HW. Supercomputing: What have we learned from the top500 project ? *Computing and Visualization in Science*, 6: 227-230, 2004.
- STROUT J. *Mind uploading home page*. 2007, 2006  
<http://www.ibiblio.org/jstrout/uploading/MUHomePage.html>.
- STUHRMANN B, JAHNKE HG, SCHMIDT M, et al. Versatile optical manipulation system for inspection, laser processing, and isolation of individual living cells. *Review of Scientific Instruments*, 77: -, 2006.
- STUMPF MPH, THORNE T, DE SILVA E, et al. Estimating the size of the human interactome. *Proceedings of the National Academy of Sciences of the United States of America*, 105: 6959-6964, 2008.
- SUZUKI M, GOTO T, TSUJI T, and OHTAKE H. A dynamic body model of the nematode *C. elegans* with neural oscillators. *Journal of Robotics and Mechatronics*, 17: 318-326, 2005.
- SWANSON J and KHEIFETS L. Biophysical mechanisms: A component in the weight of evidence for health effects of power-frequency electric and magnetic fields. *Radiation Research*, 165: 470-478, 2006.
- SZABO N. *Falsifiable design: A methodology for evaluating theoretical technologies*. 2007  
<http://unenumerated.blogspot.com/2007/02/falsifiable-design-methodology-for.html>.
- TAKAHASHI K, YUGI K, HASHIMOTO K, et al. Computational challenges in cell simulation: A software engineering approach. *Ieee Intelligent Systems*, 17: 64-71, 2002.
- TAN WH, PARPURA V, HAYDON PG, and YEUNG ES. Neurotransmitter imaging in living cells based on native fluorescence detection. *Analytical Chemistry*, 67: 2575-2579, 1995.
- TEGMARK M. Importance of quantum decoherence in brain processes. *Physical Review E*, 61: 4194-4206, 2000.
- TERAN J, SIFAKIS E, BLEMKER SS, et al. Creating and simulating skeletal muscle from the visible human data set. *Ieee Transactions on Visualization and Computer Graphics*, 11: 317-328, 2005.
- THAGARD P. How molecules matter to mental computation. *Philosophy of Science*, 69: 429-446, 2002.
- THOMAS S. *Endogenous neuroactive extracellular signal transducers*. Neurotransmitter.net, 2006  
<http://www.neurotransmitter.net/neurosignaling.html>.
- THOMSON A. Facilitation, augmentation and potentiation at central synapses. *Trends Neuroscience*, 23: 305-312, 2000.
- TIMLER J and LENT CS. Maxwell's demon and quantum-dot cellular automata. *Journal of Applied Physics*, 94: 1050-1060, 2003.
- TOLEDO-RODRIGUEZ M, BLUMENFELD B, WU CZ, et al. Correlation maps allow neuronal electrical properties to be predicted from single-cell gene expression profiles in rat neocortex. *Cerebral Cortex*, 14: 1310-1327, 2004.
- TOMITA M. *E-cell*. 2001 <http://www.e-cell.org/ecell/>.
- TOUGAW PD and LENT CS. Logical devices implemented using quantum cellular-automata. *Journal of Applied Physics*, 75: 1818-1825, 1994.
- TRAUB RD, CONTRERAS D, CUNNINGHAM MO, et al. Single-column thalamocortical network model exhibiting gamma oscillations, sleep spindles, and epileptogenic bursts. *Journal of Neurophysiology*, 93: 2194-2232, 2005.
- TRAUB RD, MILES R, and BUZSAKI G. Computer-simulation of carbachol-driven rhythmic population oscillations in the ca3 region of the invitro rat hippocampus. *Journal of Physiology-London*, 451: 653-672, 1992.

- TRAUB RD and WONG RKS. Cellular mechanism of neuronal synchronization in epilepsy. *Science*, 216: 745-747, 1982.
- TSAI PS, FRIEDMAN B, IFARRAGUERRI AI, et al. All-optical histology using ultrashort laser pulses. *Neuron*, 39: 27-41, 2003.
- TSANG WJ. *Synaptic ultrastructural reconstruction using serial electron microscopy*. 148-149, 2005
- TSENG GY and ELLENBOGEN JC. Nanotechnology - toward nanocomputers. *Science*, 294: 1293-1294, 2001.
- TSODYKS M, PAWELZIK K, and MARKRAM H. Neural networks with dynamic synapses. *Neural Computation*, 10: 821-835, 1998.
- TUSZYNSKI J. The dynamics of c-termini of microtubules in dendrites: A possible clue for the role of neural cytoskeleton in the functioning of the brain. *Journal of Geophysical Research*, 1, 2006.
- TYSON J. *Jigcell*. 2001 <http://jigcell.biol.vt.edu/>.
- UEHARA C, COLBERT C, SAGGAU P, and KAKADIARIS I. Towards automatic reconstruction of dendrite morphology from live neurons. *Conf Proc IEEE Eng Med Biol Soc*, 3: 1798-801, 2004.
- URBAN S, O'MALLEY SM, WALSH B, et al. Automatic reconstruction of dendrite morphology from optical section stacks. In *Proc. 2nd international workshop on computer vision approaches to medical image analysis, graz, austria, may 2006.*, 2006, pp. 190-201.
- VALBERG PA, KAVET R, and RAFFERTY CN. Can low-level 50/60 hz electric and magnetic fields cause biological effects? *Radiation Research*, 148: 2-21, 1997.
- VAN BRUGGEN MJ, VAN SOMEREN B, and KRUIT P. Development of a multi-electron-beam source for sub-10 nm electron beam induced deposition. *Journal of Vacuum Science & Technology B*, 23: 2833-2839, 2005.
- VAN GEIT W, ACHARD P, and DE SCHUTTER E. Neurofitter: A parameter tuning package for a wide range of electrophysiological neuron models. *Frontiers in neuroinformatics*, 1: 1-18, 2007.
- VAN SOMEREN B, VAN BRUGGEN MJ, ZHANG Y, HAGEM CW, and KRUIT P. Multibeam electron source using mems electron optical components. *Journal of Physics a-Mathematical and General*, Conference series 34: 1092-1097, 2006.
- VANIER MC and BOWER JM. A comparative survey of automated parameter-search methods for compartmental neural models. *Journal of Computational Neuroscience*, 7: 149-171, 1999.
- VENTER JC ADAMS MD MYERS EW, et al. The sequence of the human genome. *Science*, 291: 1304-+, 2001.
- VON BOHLEN UND HALBACH O and DERMETZEL R. *Neurotransmitters and neuromodulators*. Weinheim: Wiley-VCH, 2006.
- WALTER C. Kryder's law. *Scientific American*: 32-33, 2005.
- WANG Y, LIU D, and WANG Y. Discovering the capacity of human memory. *Brain and Mind*, 4: 189-198, 2003.
- WANG ZH and GRABOWSKI PJ. Cell- and stage-specific splicing events resolved in specialized neurons of the rat cerebellum. *Rna-a Publication of the Rna Society*, 2: 1241-1253, 1996.
- WEDEL BJ and GARBERS DL. Guanylyl cyclases: Approaching year thirty. *Trends in Endocrinology and Metabolism*, 9: 213-219, 1998.
- WEHNER M, OLIKER L, and SHALF J. Towards ultra-high resolution models of climate and weather. *International Journal of High Performance Computing Applications*, 22: 149-165, 2008.
- WEINSTEIN RK and LEE RH. *Design of high performance physiologically-complex motoneuron models in fpgas*. Arlington, Virginia, 2005
- WEINSTEIN RK and LEE RH. Architectures for high-performance fpga implementations of neural models. *Journal of Neural Engineering*, 3: 21-34, 2006.



- WELSER JJ, BOURIANOFF GI, ZHIRNOV VV, and CAVIN RK. The quest for the next information processing technology. *Journal of Nanoparticle Research*, 10: 1-10, 2008.
- WHITE JG, SOUTHGATE E, THOMSON JN, and BRENNER S. The structure of the nervous-system of the nematode *Caenorhabditis elegans*. *Philosophical Transactions of the Royal Society of London Series B-Biological Sciences*, 314: 1-340, 1986.
- WILKINS MR, SANCHEZ JC, WILLIAMS KL, and HOCHSTRASSER DF. Current challenges and future applications for protein maps and post-translational vector maps in proteome projects. *Electrophoresis*, 17: 830-838, 1996.
- WILSON MA, BHALLA US, UHLEY JD, and BOWER JM. Genesis: A system for simulating neural networks. In Touretzky D. (Ed.) *Advances in neural information processing systems*. San Mateo: Morgan Kaufmann, 1989, pp. 485-492.
- WISE A, JUPE SC, and REES S. The identification of ligands at orphan G-protein coupled receptors. *Annual Review of Pharmacology and Toxicology*, 44: 43-66, 2004.
- WISHART DS, TZUR D, KNOX C, et al. Hmdb: The human metabolome database. *Nucleic Acids Research*, 35: D521-D526, 2007.
- WOOD J and GARTHWAITE J. Models of the diffusional spread of nitric-oxide - implications for neural nitric-oxide signaling and its pharmacological properties. *Neuropharmacology*, 33: 1235-1244, 1994.
- XU F and DING HS. A new kinetic model for heterogeneous (or spatially confined) enzymatic catalysis: Contributions from the fractal and jamming (overcrowding) effects. *Applied Catalysis a-General*, 317: 70-81, 2007.
- YAMAMOTO Y and SHINOHARA K. Application of x-ray microscopy in analysis of living hydrated cells. *The Anatomical Record*, 269: 217-223, 2002.
- YOSHIKAWA N, MATSUZAKI F, NAKAJIMA N, and YODA K. Design and component test of a 1-bit rsfq microprocessor. *Physica C-Superconductivity and Its Applications*, 378: 1454-1460, 2002.
- YU FH, YAROV-YAROVY V, GUTMAN GA, and CATTERALL WA. Overview of molecular relationships in the voltage-gated ion channel superfamily. *Pharmacological Reviews*, 57: 387-395, 2005.
- YUCESOY CA, KOOPMAN BHFJM, HUIJING PA, and GROOTENBOER HJ. Three-dimensional finite element modeling of skeletal muscle using a two-domain approach: Linked fiber-matrix mesh model. *J Biomech*, 35: 1253-1262, 2002.
- ZENIL H and HERNANDEZ-QUIROZ F. On the possible computational power of the human mind. In Gershenson C., Aers D., and Edmonds B. (Eds.), *Worldviews, science and us: Philosophy and complexity*: World Scientific, 2007, pp. 315-334.
- ZHANG M, WANG L, and YE P. All optical xor logic gates: Technologies and experiment demonstrations. *Communications Magazine, IEEE*, 43: S19-S24, 2005.
- ZHANG WX, ZHANG Y, ZHENG H, et al. SynDb: A synapse protein database based on synapse ontology. *Nucleic Acids Research*, 35: D737-D741, 2007.
- ZHAO K, DALTON P, YANG GC, and SCHERER PW. Numerical modeling of turbulent and laminar airflow and odorant transport during sniffing in the human and rat nose. *Chemical Senses*, 31: 107-118, 2006.
- ZHENG Y, KREUWEL HTC, YOUNG DL, et al. The virtual nod mouse - applying predictive biosimulation to research in type 1 diabetes. *How Do We Best Employ Animal Models for Type 1 Diabetes and Multiple Sclerosis?*, 1103: 45-62, 2007.
- ZINOVIEV DY. Design issues in ultra-fast ultra-low-power superconductor batcher-banyan switching fabric based on rsfq logic/memory family. *Applied Superconductivity*, 5: 235-239, 1997.
- ZORDAN VB, CELLY B, CHIU B, and DiLORENZOY PC. Breathe easy: Model and control of simulated respiration for animation. In Boulic R. and Pai D.K. (Eds.), *Eurographics/acm siggraph symposium on computer animation (2004)*, 2004, pp. 29-37.

- ZUBEK JP and MACNEILL M. Effects of immobilization - behavioural and eeg changes. *Canadian Journal of Psychology*, 20: 316-316, 1966.
- ZUO Y, LIN A, CHANG P, and GAN WB. Development of long-term dendritic spine stability in diverse regions of cerebral cortex. *Neuron*, 46: 181-189, 2005.